

# **EVERLAST**

## **LIGHTNING MTS 275**

*Digitally-Controlled, Multi-Process MIG/AC-DC TIG/Stick Welder*

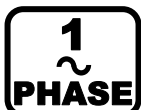

### **Operator's Manual for the Lightning MTS 275**

### **Safety, Setup and General Use Guide**

[everlastwelders.com](http://everlastwelders.com)

Rev. 1 0 11220-19



1-877-755-9353  
329 Littlefield Ave. South San Francisco, CA 94080 USA

Specifications and Accessories subject to change without notice.

# TABLE OF CONTENTS

CUSTOMER GREETING	3
EVERLAST CONTACT INFORMATION	4
SAFETY INSTRUCTIONS	5
PERFORMANCE/DESIGN SPECIFICATIONS	9
ELECTRICAL INPUT/OUTPUT/DUTY CYCLE	10
GENERAL PRODUCT AND USE INFORMATION	11
DUTY CYCLE AND WARNINGS	12
SUMMARY OF FEATURES	13
GENERAL MIG/FLUX-CORED/DRIVE ROLL INFORMATION	14
MIG GUN AND WIRE SPOOL INSTALLATION	18
CONNECTING GAS AND REGULATOR INFORMATION	20
GAS SELECTION AND GAS FLOW RATE	22
CABLE CONNECTIONS AND POLARITY	23
MIG CONNECTION	24
FLUX-CORED CONNECTION	25
SPOOL GUN CONNECTION	26
DC TIG CONNECTION	27
AC TIG CONNECTION	28
STICK CONNECTION	29
SETTING UP WELDING PARAMETERS	30
OVERVIEW OF POWERSSET FUNCTION	31
BOOT SCREEN MENU	32
NAVIGATION AND ADJUSTMENT SUMMARY	33
TIG STEEL/STAINLESS (DC TIG) SETUP AND PARAMETER INFORMATION	34
TIG ALUMINUM (AC TIG) SETUP AND PARAMETER INFORMATION	42
MIG/FLUX-CORED SETUP AND PARAMETER INFORMATION	31
STICK SETUP AND PARAMETER INFORMATION	60
PROGRAM/MEMORY SETUP AND ADJUSTMENT	65
FRONT PANEL VIEW AND COMPONENT ID	68
SIDE ACCESS PANEL VIEW AND COMPONENT ID	70
REAR PANEL VIEW AND COMPONENT ID	72
MIG TORCH COMPONENT VIEW AND ID	74
TIG TORCH COMPONENT VIEW AND ID	75
MIG OPERATION AND THEORY	76
STICK OPERATION AND THEORY	85
TIG OPERATION AND THEORY	87
TROUBLE SHOOTING/WARNING SCREEN INFORMATION	95
BASIC TROUBLE SHOOTING	98

Dear Customer,

**THANKS!** You had a choice, and you bought an Everlast product. We appreciate you as a valued customer and hope that you will enjoy years of use from your welder.

Please go directly to the Everlast website to register your unit and receive your warranty information. Your unit registration is important should any information such as product updates or recalls be issued. It is also important so that we may track your satisfaction with Everlast products and services. If you are unable to register by website, contact Everlast directly through the sales department at the main customer service number in your country. Your unit's warranty will be registered and in full effect. Keep all information regarding your purchase, including date of purchase and receipt. **In the event of a problem with your unit or other issue you must contact technical support before your welder can be a candidate for warranty service and returned. An over-the-phone review/diagnosis must be performed BEFORE a RMA will be issued or before the unit can be sent in for service.**

**Please read the warranty statement published online and other important information found on the Everlast website of the division located in or nearest to your country. This includes the terms of the purchase and warranty procedure. Print it for your records and become familiar of its terms and conditions. Please note that Guns, accessories and torches are covered under a separate, shorter warranty. Please be sure you visit the website and are familiar with all the warranty terms before you call for service.**

Everlast offers full technical support, in several different forms. We have online support available through email, and a welding support forum designed for our customers and non-customers to interact with each other. Technical advisors are active on the forum daily. We also divide our support into two divisions: technical and welding performance. Should you have an issue or question concerning your unit, please contact performance/technical support available through the main company headquarters available in your country. This support is free to all Everlast customers. For best service call the appropriate support line and follow up with an email, especially during weekends, holidays or any off hours when you cannot reach a live person. In the event you do not reach a live person, leave a message and your call will normally be returned within 24 hours, except for weekends and holidays. Also, for quick answers to your basic questions, join the company owned forum available through the website. You'll find knowledgeable staff available to answer your questions. You also may find a topic that already addresses your question at <http://www.everlastgenerators.com/forums/>. Should you need to call or write, always know your model name, purchase date and welder manufacturing inspection date. This will assure the quick and accurate customer service. **REMEMBER: Be as specific and informed as possible. Technical and performance advisors rely upon you to carefully describe the conditions and circumstances of your problem or question. Take notes of any issues as best you can. You may be asked many questions by the advisors to clarify problems or issues that may seem very basic. However, diagnosis procedures MUST be followed to begin the warranty process. Advisors can't assume anything (even with experienced users) and must cover all aspects to properly diagnose the problem. Depending upon your issue, it is advisable to have basic tools handy such as screwdrivers, wrenches, pliers, and even an inexpensive test meter with volt/ohm functions before you call.**

Let us know how we may be of service to you should you have any questions.

Sincerely,

Everlast Customer Service



Serial number: \_\_\_\_\_  
Model number: \_\_\_\_\_  
Date of Purchase \_\_\_\_\_

**Everlast USA:**

Everlast consumer satisfaction email: [sales@everlastwelders.com](mailto:sales@everlastwelders.com)  
Everlast Website: [everlastwelders.com](http://everlastwelders.com)  
Everlast Technical Support: [tech@everlastwelders.com](mailto:tech@everlastwelders.com)  
Everlast Welding Support: [performance@everlastwelders.com](mailto:performance@everlastwelders.com) Everlast Support  
Forum: <http://www.everlastgenerators.com/forums/index.php>  
Main toll free number: 1-877-755 WELD (9353) 9am—5pm PST M-F

FAX: 1-650-588-8817

**Everlast Canada:**

Everlast consumer satisfaction email: [sales@everlastwelders.ca](mailto:sales@everlastwelders.ca)  
Everlast Website: [everlastwelders.ca](http://everlastwelders.ca)  
Everlast Technical Support: [sales@everlastwelders.ca](mailto:sales@everlastwelders.ca)  
Telephone: 905-637-1637 9am-4:30pm EST M-F

**Everlast Australia:**

Port Macquarie 4/18  
Acacia Ave.  
Port Macquarie NSW 2444  
(02) 6581 23888  
After Hours Support  
0431 016 416  
Sales: [sales@everlastwelders.com.au](mailto:sales@everlastwelders.com.au)  
Support: [support@everlastwelders.com.au](mailto:support@everlastwelders.com.au)

**NOTICE:**

Product Specifications and features are subject to change without notice. While every attempt has been made to provide the most accurate and current information possible at the time of publication, this manual is intended to be a general guide and not intended to be exhaustive in its content regarding safety, welding, or the operation/maintenance of this unit. Everlast Power Equipment INC. does not guarantee the accuracy, completeness, authority or authenticity of the information contained within this manual. The owner of this product assumes all liability for its use and maintenance. Everlast Power Equipment INC. does not warrant this product or this document for fitness for any particular purpose, for performance/accuracy or for suitability of application. Furthermore, Everlast Power Equipment INC. does not accept liability for injury or damages, consequential or incidental, resulting from the use of this product or resulting from the content found in this document or accept claims by a third party of such liability.



Everlast is dedicated to providing you with the best possible equipment and service to meet the demanding job requirements that you may have. We want to go beyond delivering a satisfactory product to you. That is the reason we offer free technical and basic welding support to assist you with your needs, should an occasion occur where it is needed. With proper use and care your product should deliver years of trouble free service.



**Safe operation and proper maintenance is your responsibility.**

We have compiled this operator's manual, to instruct you in basic safety, operation and maintenance of your Everlast product to give you the best possible operator/owner experience. Welding and related cutting operations require basic experience and common sense. **Exercise extreme caution and care in all activities related to welding or cutting. Your safety, health and even life depends upon it.**

*While accidents are never planned, preventing an accident requires careful planning. Stay alert!*

**Please carefully read this manual before you operate your Everlast unit.** This manual, if read in full, can assist the user in obtaining helpful information concerning the safe operation of this unit. Do not operate the unit until you have read this manual and you are thoroughly familiar with the safe operation of the unit. If you feel you need more information please contact Everlast Support. The content of this manual is not meant to be an exhaustive primer on welding. It is written to an audience that, if not professional, will have at least some basic knowledge of welding terms and practices.

The 5 year warranty does not cover improper use, maintenance, accessories or consumables. Accessories are covered by a separate warranty (length varies), which is also listed on our website along with the full terms of the welder warranty. Consumables have no warranty.

**Do not attempt to alter or defeat any piece or part of your unit, particularly any safety device.** Keep all shields and covers in place during unit operation should an unlikely failure of internal components result in the possible presence of sparks and explosions. If a failure occurs, discontinue further use until malfunctioning parts or accessories have been repaired or replaced by qualified personnel.



**Note on High Frequency electromagnetic disturbances:**

Certain welding and cutting processes generate High Frequency (HF) waves. These waves may disturb sensitive electronic equipment such as televisions, radios, computers, cell phones, and related equipment. High Frequency may also interfere with fluorescent lights. Consult with a **licensed** electrician if disturbance is noted. Sometimes, improper wire routing or poor shielding may be the cause.



**WARNING!** HF can interfere with pacemakers. See EMF warnings in following safety section for further information. Always consult your physician before entering an area known to have welding or cutting equipment if you have a pacemaker.

## Safety Precautions



These safety precautions are for protection of safety and health. Failure to follow these guidelines may result in serious injury or death. Be careful to read and follow all cautions and warnings. Protect yourself and others.



**Welding and cutting processes produce high levels of ultraviolet (UV) radiation that can cause severe skin burn and damage.** There are other potential hazards involved with welding such as severe burns and respiratory related illnesses. Therefore observe the following to minimize potential accidents and injury:



**Use appropriate safety glasses with wrap around shields while in the work area, even under welding helmets to protect your eyes from flying sparks and debris.** When chipping slag or grinding, goggles and face shields may be required.



**When welding or cutting, always use an approved shielding device, with the correct shade of filter installed.** Always use a welding helmet in good condition. Discard any broken or cracked filters or helmets. Using broken or cracked filters or helmets can cause severe eye injury and burn. Filter shades of no less than shade 5 for cutting and no less than shade 9 for welding are highly recommended. Shades greater than 9 may be required for high amperage welds. Keep filter lenses clean and clear for maximum visibility. It is also advisable to consult with your eye doctor should you wear contacts for corrective vision before you wear them while welding.



**Do not allow personnel to watch or observe the welding or cutting operation unless fully protected by a filter screen, protective curtains or equivalent protective equipment.** If no protection is available, exclude them from the work area. Even brief exposure to the rays from the welding arc can damage unprotected eyes.



**Always wear hearing protection because welding and cutting can be extremely noisy. Ear protection is necessary to prevent hearing loss.** Even prolonged low levels of noise has been known to create long term hearing damage. Hearing protection also further protects against hot sparks and debris from entering the ear canal and doing harm.



**Always wear personal protective clothing.** Flame proof clothing is required at all times. Sparks and hot metal can lodge in pockets, hems and cuffs. Make sure loose clothing is tucked in neatly. Leather aprons and jackets are recommended. Suitable welding jackets and coats may be purchased made from fire proof material from welding supply stores. Discard any burned or frayed clothing. Keep clothing away from oil, grease and flammable liquids.



**Leather boots or steel toed leather boots with rubber bottoms are required for adequate foot protection.** Canvas, polyester and other man made materials often found in shoes will either burn or melt. Rubber or other non conductive soles are necessary to help protect from electrical shock.



**Flame proof and insulated gauntlet or cuffed type gloves are required whether welding or cutting or handling metal.** Simple work gloves for the garden or chore work are not sufficient. Gauntlet type welding gloves are available from your local welding supply store.



**This welder contains moving parts that can result in injury.** Keep hands, fingers, hair, and loose clothing away from the wire feeding mechanisms and fans while unit is switched on and in use. Do not attempt to defeat any safety feature. Always operate unit with guard in place on the wire feeder.

## Safety Precautions



**WARNING!** Persons with pacemakers should not weld, cut or be in the welding area until they consult with their physician. Some pacemakers are sensitive to EMF radiation and could severely malfunction while welding or while being in the vicinity of someone welding. *Serious injury or death may occur!*



**Welding and plasma cutting processes generate electro-magnetic fields and radiation.** While the effects of EMF radiation are not known, it is suspected that there may be some harm from long term exposure to electromagnetic fields. Therefore, certain precautions should be taken to minimize exposure:

- Lay welding leads and lines neatly *away* from the body.
- Never coil cables *around* the body or limbs.
- Secure cables with tape if necessary to keep from the body.
- Keep all cables and leads on the same side the body.
- Never stand between cables or leads.
- Keep as far away from the power source (welder) as possible while welding.
- Never stand between the ground clamp and the torch.
- Keep the ground clamp grounded as close to the weld or cut as possible.



**Welding and cutting processes pose certain inhalation risks.** Be sure to follow any guidelines from your chosen consumable and electrode suppliers regarding possible need for respiratory equipment while welding or cutting. Always weld with adequate ventilation. Never weld in closed rooms or confined spaces. Fumes and gases released while welding or cutting may be poisonous. Take precautions at all times.

Any burning of the eyes, nose or throat are signs that you need to increase ventilation. Stop immediately and relocate work if necessary until adequate ventilation is obtained. Stop work completely and seek medical help if irritation and discomfort persists.



**WARNING!** Do not weld on galvanized steel, stainless steel, beryllium, titanium, copper, cadmium, lead or zinc without proper respiratory equipment and or ventilation.



**WARNING!** This product can expose you to chemicals such as lead, which is known to the State of California to cause birth defects, reproductive harm and cancer. Proposition 65 Warning. For more information visit: [www.P65Warnings.ca.gov](http://www.P65Warnings.ca.gov)



**DANGER!** Do not weld or cut around Chlorinated solvents or degreasing areas. Release of Phosgene gas can be deadly. Consider all chemicals to have potential deadly results if welded on or near metal containing residual amounts of chemicals.



**Keep all cylinders upright and chained to a wall or appropriate holding pen.** Certain regulations regarding high pressure cylinders can be obtained from OSHA or local regulatory agency. Consult also with your welding supply company in your area for further recommendations. The regulatory changes are frequent so keep informed.



**All cylinders have a potential explosion hazard.** When not in use, keep capped and closed. Store chained so that overturn is not likely. Transporting cylinders incorrectly can lead to an explosion. Do not attempt to adapt regulators to fit cylinders. Do not use faulty regulators. Do not allow cylinders to come into contact with work piece or work. Do not weld or strike arcs on cylinders. Keep cylinders away from direct heat, flame and sparks.

## Safety Precautions



**WARNING! Electrical shock can kill.** Make sure all electrical equipment is properly grounded. Do not use frayed, cut or otherwise damaged cables and leads. Do not stand, lean or rest on ground clamp. Do not stand in water or damp areas while welding or cutting. Keep work surface dry. Do not use welder or plasma cutter in the rain or in extremely humid conditions. Use dry rubber soled shoes and dry gloves when welding or cutting to insulate against electrical shock. Turn machine on or off only with gloved hand. Keep all parts of the body insulated from work, and work tables. Keep away from direct contact with skin against work. If tight or close quarters necessitates standing or resting on work piece, insulate with dry boards and rubber mats designed to insulate the body from direct contact.



**All work cables, leads, and hoses pose trip hazards.** Be aware of their location and make sure all personnel in area are advised of their location. Taping or securing cables with appropriate restraints can help reduce trips and falls.



**WARNING! Fire and explosions are real risks while welding or cutting.** Always keep fire extinguishers close by and additionally a water hose or bucket of sand. Periodically check work area for smoldering embers or smoke. It is a good idea to have someone help watch for possible fires while you are welding. Sparks and hot metal may travel a long distance. They may go into cracks in walls and floors and start a fire that would not be immediately visible. Here are some things you can do to reduce the possibility of fire or explosion:

- Keep all combustible materials including rags and spare clothing away from area.
- Keep all flammable fuels and liquids stored separately from work area.
- Visually inspect work area when job is completed for the slightest traces of smoke or embers.
- If welding or cutting outside, make sure you are in a cleared off area, free from dry tender and debris that might start a forest or grass fire.
- Do not weld on tanks, drums or barrels that are closed, pressurized or anything that held flammable liquid or material.



**Metal is hot after welding or cutting!** Always use gloves and or tongs when handling hot pieces of metal. Remember to place hot metal on fire-proof surfaces after handling. Serious burns and injury can result if material is improperly handled.



**WARNING! Faulty or poorly maintained equipment can cause injury or death.** Proper maintenance is your responsibility. Make sure all equipment is properly maintained and serviced by qualified personnel. Do not abuse or misuse equipment. Remove any faulty cords, plugs or electrical equipment from service or access. Keep all covers in place. A faulty machine may shoot sparks or may have exploding parts. Touching uncovered parts inside machine can cause discharge of high amounts of electricity. **Do not allow employees to operate poorly serviced equipment.** Always check condition of equipment thoroughly before start up.



Disconnect unit from power source before any service attempt is made and for long term storage or electrical storms. **If operating on a generator:** Always switch off and disconnect the unit before shutting the unit down. Never start the generator with the unit switched on or connected. Failure to do so may result in damage to the unit. **This damage is not covered under warranty.** Make sure that any required generator grounding is performed properly and to the manufacturer's recommendations.



Further information can be obtained from The American Welding Society (AWS) that relates directly to safe welding and plasma cutting. Additionally, your local welding supply company may have additional pamphlets available concerning their products. Do not operate machinery until you are comfortable with proper operation and are able to assume inherent risks of cutting or welding.

## General Performance Specifications

## Lightning MTS 275

MIG/TIG/Stick Amp Range	120V: MIG 30-150A/ TIG DC: 10-150A, AC: 15-150A / Stick 10-120A 240V: MIG 30-250A/ TIG DC: 10-250A, AC: 15-250A / Stick 10-200A
MIG Output Type	Standard, non-pulse, with Flux-Cored Capability. Spool gun ready. (Spool gun is optional)
Volt Adjustment Range MIG	120V: 15.5-22V 240V: 15.5-30V
MIG Wire Feed Speed	120V: 60-400 (5-10 m/min) 240V: 60 to 600 IPM (.5-15 m/min)
Input Voltage	120-240V Single phase (208V is permissible but the Power Set function accuracy may be affected.)
Welder Type	Digitally controlled, IGBT inverter type with CV Synergic MIG/Flux-Cored, CC AC-DC Pulse TIG, CC Stick functions and Spool Gun capability.
Screen Type	Digital 4.3" TFT color display
Wire Roll Size and Diameter	.023"-.063" (.6mm to 1.6mm) wire diameters possible with optional drive rolls. .030" to .45" (.6mm to 1.2mm recommended for most applications) <b>Use optional smaller gun for best results for .023"/.6mm wire.</b> 12" diameter roll (Up to 44 lbs.); 8" adapter available (10-12 lbs.); <u>Notice: 4" Diameter not supported.</u>
Pre/Post Flow Control MIG/TIG	MIG: (Pre) 0-10 Seconds/ (Post) 0-10 Seconds; TIG (Pre) 0-10 Seconds/ (Post) 0-10 Seconds
Up/Down Slope of MIG Volts/ TIG Amps	MIG: 0-1 Second, TIG: 0-10 Seconds
Power Set Synergic Function	Synergic operation in MIG, TIG and Stick modes, which uses operator inputs of electrode/wire sizes, metal thickness, and metal type to predict and set a workable range of amperage.
MIG Burn Back Timer Control	0-2 seconds
Inductance/Arc Force Control	0-100%
TIG Output Type	AC/DC with Pulse Control and Wave Form Selection
TIG Wave Forms on AC	4 wave forms: Advanced Square, Soft Square, Triangular and Sine
AC TIG Frequency	20-200Hz
AC Balance	30-70% of Electrode Positive (+)
TIG Standard Pulse Frequency (AC/DC)	.5-150Hz
Advanced AC Pulse (Mix of AC and DC-)	.5-10Hz
Base Pulse TIG Amps ( Both Pulse Forms)	3-95% of Peak Amps
TIG Pulse Time On/Balance (Both Pulse Forms)	5-95%
Memory	Saves up to 15 programs.
MIG/TIG Spot and Stitch Timer	Spot: .5-15 Seconds Stitch: 0-15 Seconds
MIG Burn Back Timer	0-2 Seconds
Stick Output Type	DC
Stick Hot Start Timer	0-2 Seconds
Stick Hot Start Intensity Control	0-100% over set welding amperage
Stick E6010 Capability	Yes
Power Cable Length	9.5 ft. (3m)
Accessories	36 Series MIG torch ( some units, 25 Series) torch 9.5 ft. (3m), 18 Series water-cooled TIG torch (some units, 26 series), Work clamp with cable 9.5 ft. (3m). 300 A Stick torch with cable (3m), Floating ball type regulator.
Weight	83 lbs. / 38Kg
Dimensions	26"L x 11"W x 21.75"H(24.86" with handle) / 660mm L x 280mm W x 553mm H (632mm with handle)
Recommended Generator Minimum	12,000W Surge with Clean power output (See detailed information next page.)
Efficiency	≥80%

# Electrical Specifications

<b>EVERLAST</b> LIGHTNING MTS 275		MODEL: Lightning MTS 275		Serial No.			
		EN/ IEC60974.1					
		240V; DC: 30-250A; 15.5-26.5V		120V; DC: 30-150A; 15.5-21.5V			
		X	60%	100%	35%	60%	100%
	$U_0$ V 74V	I2	250A	200A	NA	150A	90A
		U2	26.5V	24V	NA	21.5V	20V
		240V; DC: 10-250A; 10.4-20V AC: 15A-250A; 10.6-20V		120V; DC: 10-150A; 10.4-16V AC: 15-150A; 10.6V to 250A/20V			
		X	60%	100%	35%	60%	100%
	$U_0$ V 74V	I2	250A	200A	NA	NA	150A
		U2	20V	18V	NA	NA	16V
		240V; DC: 10-200A; 20.4-28V		120V; DC: 10-120A; 20.4V-24.8V			
		X	60%	100%	40%	60%	100%
	$U_0$ V 74V	I2	200A	160A		120A	90A
		U2	28V	26.4V		24.8V	23.6V
 1~ 50/60 Hz	$U_i$ 120-240V	120V I <sub>1MAX</sub> : 42.8A I <sub>1EFF</sub> : 34A 240V I <sub>1MAX</sub> : 44.9A I <sub>1EFF</sub> : 35A					
PROTECTION CLASS IP21S	COOLING METHOD: 4 FULL-TIME FANS	INSULATION: F		WIRE SPEED: 240V: 60-600 IPM 120V: 60-400 IPM			

### IMPORTANT!

Keep this welder at least 18 inches away from all objects for proper cooling. This unit uses multiple fans at different spots within the machine for cooling. For this reason, proper spacing is imperative from all sides. Do not exceed 40° C in environment or duty cycle will be reduced. Regularly inspect and clean the welder and circuitry on a monthly basis with dry compressed air. Remove the covers only after the unit has been turned off and unplugged for 30 minutes to discharge the capacitors and to prevent the possibility of electrocution. Do not grind or direct sparks near the welder to prevent damage to the panel face and internal components. Check fan blades for build up and metal scale/dust and remove carefully. Failures or damages to the unit due to accumulation of dirt and debris on circuit boards or fan blades are not covered under warranty. Opening your unit up to clean or adjust the unit does not void your warranty, and in fact ensures your unit will perform correctly and will uphold your warranty.

### NOTICE:

This welder conforms to North American electrical standards for 120V and 240V single phase welders, including plug type (NEMA 6-50P) and wire gauge. When wiring a new electrical service or modifying an existing electrical service for use with this welder, always consult with a local, licensed electrician. Refer to Article 630 of the NEC and to the I<sub>1MAX</sub> (Inrush Current) and the I<sub>1EFF</sub> (Effective rated current) listed above when selecting breaker size and the wire gauge to ensure that your installation will conform to national and local electrical codes for welding equipment. Wiring codes for welders differ from wiring codes for household electrical equipment for both plug type, breaker and wire sizing. **Do not attempt to rewire this welder, or make similar unapproved modifications to this welder. To do so will void the warranty.** To operate on 120V, use the supplied adapter to adapt the unit from 240V operation to 120V operation. The unit will automatically adapt once the unit is switched on. When operating on 120V, the output is reduced. See information above for range of output and duty cycle ranges operating on 120V and 240V.

## General Product and Use Information

### NOTICE:

This manual has been compiled to give an overview of operation and is designed to offer information centered around **safe, practical use of the welder and its functions**. Welding operations are inherently dangerous. Only the operator of this welder can ultimately ensure that safe operating practices are being followed, through the exercise of common sense practices and training. **Do not operate this machine until you have fully read the manual, including the safety section.** If you do not have the skill or knowledge to safely operate this unit and its related functions, do not use this welder until formal training is received. *Always be aware of your surroundings and operating environment and who and what is in that environment.*

### GENERAL PRODUCT INFORMATION:

The Lightning MTS 275 is a multi-process welder with DC MIG, Flux-cored, AC/DC Pulse TIG, and DC Stick welding capabilities. The design of the Lightning MTS 275 is a second generation design of the Industry's first series of true multi-process welder design with AC/DC TIG capability. This welder has a fully integrated digital design that includes a 4.3" TFT LCD color display and self-diagnosing features and can operate on 120V or 240V input. Advanced AC TIG Pulse capability, adjustable wave forms (increased to 4) for AC TIG welding, increased memory, Power Set synergic function in all welding modes and a lower amp AC start are all new or improved features for this unit. Dual gas inlets for TIG and MIG have also been added. The simple and intuitive operator interface allows the operator to view most settings at a glance and quickly adjust them without accessing additional levels of menus. This reduced step menu design is unique and has been carefully designed for quickest and easiest access and adjustment.

### GENERATOR REQUIREMENTS AND OPERATION

This unit may be run on a generator capable of 12,000 Surge Watts. Additionally, the generator must provide "clean power". Clean power is defined as having 5% or less Total Harmonic Distortion (THD). This is a rating given by the manufacturer of the generator, and not Everlast. This is similar to the power normally supplied at a wall outlet. This represents a sine wave (AC) that is mostly free of voltage spikes and electronic noise. Many general purpose (GP) generators are not rated to produce clean power and are designed for emergency or construction use with resistive loads such as lights or heaters. These generators can damage the plasma cutter. If damage does not occur immediately, the effect can be cumulative, depending on how "dirty" the power actually is. Damage created by running this unit off a generator, or welder/generator not rated for clean power output by its manufacturer will not be covered under warranty. If you are in doubt about your generator or welder/generator, contact the manufacturer. Everlast does not keep an authorized list of generator brands or models. If the manufacturer rates its generator for 5% or less THD, this is sufficient to meet Everlast's stated standards. Use due diligence to perform additional research on the brand and model of the generator to make certain there are no recalls or reported equipment (electronics in particular) damage related to malfunctioning generators.

The generator should be properly grounded, according to the generator manufacturer instructions.

**Never leave the unit on or connected while starting the generator. Never stop the generator while the unit is on or connected. Severe damage will occur. This includes running the generator low on or out of fuel. This damage is not covered under warranty, even if the unit is rated as "clean powered".** Always allow the generator to warm up before plugging the unit in and using it. A cold engine may not develop or maintain proper RPM needed to provide stable, clean power even if the unit is rated to be "clean power". Never use economy idle (ECO mode), or auto idle modes with this unit. Use high idle whenever connected to the welder.

### WARNING!

- Do not use the welder in damp or wet areas. Perspiration and other forms of water in contact with the body can increase the risk of electrocution.
- Do not use the welder in corrosive environments.
- If used on a mobile cart, strap or fix the welder to the cart so that accidental overturn is not likely.

## General Product and Use Information

### DUTY CYCLE AND ERROR CODES

This Multi-Process welder features a self-diagnosing feature, which will display an error and a numeric error code that corresponds to a known fault or error, when a problem has occurred.

This unit has a duty cycle rating of 60% @ 250 Amps while welding in MIG and TIG mode. The duty cycle rating for stick is 60% @ 200 Amps. *The duty cycle rating is the amount of time (expressed as a percentage) out of 10 minutes the unit can weld without a rest at 40°C. Increases or decreases in temperature, humidity and air flow around the unit can change the stated duty cycle. If temperature is lowered, duty cycle generally increases.*

In MIG mode, the unit is capable of welding 6 minutes out of every 10 minutes at the maximum output of 250 Amps. For the balance of the 10 minute period, the unit should be allowed to rest and cool while running. The same rating applies to TIG. Stick is also rated for a 6 out of 10 minute welding period but at the maximum of 200 Amps output. If the unit's duty cycle has been exceeded, the "Over Temperature" will be displayed and welding output will cease. If the unit has over heated and triggered the duty-cycle "Over Temperature" warning, allow the unit to run and cool for 15 minutes. After 15 minutes of cooling while the unit is kept running, cycle the power switch to reset the unit if it has not already reset automatically.

In the event of an overcurrent, the welding output will cease and an Warning screen will be displayed. In duty cycle and overcurrent events, the wire may continue to feed without welding output. Overcurrent events can be caused by too low of supply voltage, running on undersized extension cords, too large of wire diameter, or internal or external electrical fault. When an overcurrent has occurred, turn the machine off immediately, then check and remedy the fault before cycling the welder back on. **If the error does not clear after cycling, cease operation and call Everlast Technical Support.** When the "Overcurrent Warning" screen appears, the overcurrent has likely caused an internal fault. This is usually a result of a poor power supply, a long extension cable, or from running off of a generator that is malfunctioning.

### NOTICE:

If the unit screen goes blank and stops feeding wire while welding, this is probably a blown fuse. This is a 10A fast-blow glass fuse, which is located on the rear of the machine. *This typically happens when rapid or extended tacking or hole filling is occurring with a long wire stick out.* Replacements may be bought locally. Do not attempt to use any other type fuse including higher amp fuses or it may damage the unit. The common designation/part number for this fuse is **F10AL**. Contact Everlast if the fuse continues to blow.

### HELPFUL HINT:

Keep the clear protective cover lowered during operation to prevent damage to the LCD screen from sparks and dust. For further protection, purchase a customizable (one-size-fits-all) cell phone screen protector. Trim the cover to fit the screen and apply it to the display. Replace the cover when it becomes scratched or dirty. Use only a soft cloth designed for computer screen cleaning to clean the display screen. This will help prevent damage to the LCD screen, and ensure years of reliable performance from the display.



## Discussion of Welder Features and Operation

### SUMMARY OF FEATURES

#### GMAW Process (MIG) and F-CAW (Flux-Cored)

The digitally controlled components of this welder precisely control wire feeding and arc quality. It also gives real-time feed back about the welding output parameters. The welder is also spool gun (gun optional) ready for economical welding of Stainless and Aluminum wires if needed. It can also be used to weld with Flux Cored and Dual Shield wire (when equipped with optional flux core drive wheels). However, since there is no Dual Shield Power-Set feature, Dual-Shield can only be done in standard MIG mode. The unit is equipped with a heavy duty 36 series MIG gun. **NOTICE:** *This unit does not support a Push-Pull gun. It does not have a Pulse-MIG mode.*

#### GTAW (TIG) Process

The TIG mode of the welder features both AC and DC output which is suitable for welding all metals when required. It includes a high frequency start and a lift start function to give the operator maximum flexibility welding in areas that restrict HF use. A fully adjustable AC mode with AC wave form selection feature allows the user to weld Aluminum and Magnesium. A fully adjustable pulse feature is also included to help control heat and distortion. It can also be used to improve bead appearance. A key feature of this welder's design places all connections on the front of the panel instead of under the spool cover. No install kits are necessary to make the unit TIG ready. A *separate* gas solenoid is used to automatically control gas flow when the arc is started and stopped according to the time set on the panel. A foot pedal or torch switch is used to control the TIG function. The pedal controls the Amps when plugged in. Similarly, the torch switch provided with the TIG torch can be used to control the functions listed on the display. The sequencer can be used to preset Start/End Amp and Up/Down-Slope parameters to work in conjunction with the torch switch. It is also used to control other aspects of the weld parameters that may be related to 2T/4T torch switch, finger amptrol, or foot pedal operation. The unit is ready to TIG weld (with the exception of Tungsten and shielding gas) when it arrives. Additional TIG consumable kits can be purchased from Everlast or from local sources. The torch is a standard series torch and readily interchanges parts with torches from other brands of the same series. (See torch neck for series number.)

#### SMAW (Stick) Process

In stick mode the welder delivers a smooth DC low spatter arc. Professional, high-quality welds are obtainable with E7018, 7014, 309L, 316L, 6011 and many other similar rods that are designed for use with any DC stick welder. This unit is optimized for welding E6010. This setting also works well with the easier-welding E6011. The Stick mode also features adjustable hot start time and hot start intensity controls which are designed to help reduce sticking during arc starts while simultaneously reducing porosity or inclusions during arc initiation. **NOTICE:** *This unit does not provide AC operation in stick mode.*

#### Burn Back Control (MIG/Flux-Cored)

Burn back control is used to control the length of the wire stick-out after the trigger is released. It helps to prevent the welding wire from sticking in the coalescing weld puddle after the arc is terminated and saves the user from having to trim the wire before restarting the arc. The burn back keeps the arc energized for the time specified by the user after the wire feeder stops feeding. This allows the wire to be trimmed back. For most welding applications, this should be kept between .1 and .5 seconds. To achieve maximum effect, keep the gun held over the weld for a second after welding has stopped.

#### Spot and Stitch Timer

The spot timer function is frequently used in fabrication applications where consistent tack welds are required. This creates a timed arc pulse when the MIG gun trigger is activated. The Stitch timer is used in conjunction with the spot timer to create a regular on/off cycle of the arc while the gun trigger is held to control heat input and to make consistent seam weld during production.

#### Wave Form Control (AC TIG Mode Only)

Wave form simply refers to the shape of the AC wave created as the AC cycles between positive and negative polarity creating "peaks and valleys". The shape of the wave form can be varied from a pure sine wave to a rigid shouldered square wave. In practical terms, the wave form selection allows the user to tailor the arc to the look and feel that is desired. Each wave form has distinct patterns which distinguish them from one another. This unit has four distinct wave forms.

- **Advance Square Wave.** The wave form produces a strong, fast wetting arc and puddle. Along with a very stable arc, it provides rapid welding speeds and provides the most "heat" in a weld. This is the default wave form.
- **Soft Square Wave.** This is similar to the advanced square wave but has a softer, less aggressive feel. It still offers advantage of a good wet in and stable arc but offers a buttery, smooth feel. Similar to a square-wave transformer wave form.
- **Triangular Wave.** Good for light gauge metals, it offers great control and good bead profile on thin gauge metals. The way the wave form is shaped, it spends the least amount of time fully "on" at the peaks, so output will seem reduced and even the meter may show a lower top end output. However, due to the way the wave form is shaped, the meter reads a lower output than actual computed output because of the lower average amperage, but the unit still reaches the maximum peaks/valleys.
- **Sine Wave.** Sine wave is the original AC TIG wave form. It is softer than the others. It is slower to wet in and has a wider arc.

## Discussion of Welder Features and Operation

## SUMMARY OF FEATURES

**Pulse TIG Mode**

The pulse TIG feature can be employed to control heat, wicking of the puddle and reduce the arc cone diameter, improving the directability of the arc. The Pulse TIG mode has three components: Pulse Amps, Pulse Frequency, and Pulse Time-On. Each feature works together with the others to change the shape of the welding arc, average heat, puddle control, wet-in and penetration. Adjusting pulse, unless dictated by a welding protocol, does not strict guidelines. Each one of the three components can be adjusted independently when the pulse is on. Each one has its own affect on heat input, and each component of the pulse can be used somewhat to offset the effects of another pulse component, or it can be used to increase the effect of another pulse component. The goal of using pulse is usually for heat control in higher pulse frequencies, and in lower pulse frequencies, (usually .5 to 10 Hz), the goal is for a more aesthetic appearance and rod dip timing. The Advanced AC Pulse is used for Aluminum only and features a mix of AC and DC- "halves" of the Pulse cycle. This greatly extends the welding capacity of the machine up to 50% by cycling between AC and DC-, one half providing cleaning, while the other half provides increased penetration.

**Pre and Post Flow Control**

The adjustable Pre and Post flow control features are designed to improve weld quality at the beginning and end of the weld where porosity from oxidation can be a problem. This is accomplished by providing adjustable time controls for both pre flow and post flow of shielding gas. This control is active for both MIG and TIG. It is not relevant in Flux-Core operation.

**Start and End Amps/Wire Feed Speed**

The Start and End Amp feature for TIG controls the beginning amperage and ending Amperage during the weld cycle. The Start Amp feature can be used to create a very soft, light low Amp start, or it can be used to set a very hot, penetrating start. When using larger diameter tungsten, it is a good idea to raise the minimum start 10 to 15 amps for the best starts, or arc starting may be difficult. 1/16th and .040" tungsten offers the best starts at the lowest start amp settings. End amps can be used at a lower amperage to fill craters and slow the weld cooling process to help prevent cracking at the end of the weld.

**DC TIG Minimum Start Amps: 10A ; AC TIG Minimum Start Amps: 15A**

For MIG, this controls starting wire speed and ending wire speed. It stays active until the arc is established or 4T operation signals the wire to speed up. Lowering the Start wire feed speed helps to provide a similar effect as TIG hot start, by lowering wire run in speed while maintaining a higher voltage. This will cause a more rapid burn off of wire at the beginning of the weld, and help prevent "cold start" porosity, and arc stuttering at the beginning of a weld. *To neutralize the effects of this feature, set starting/ending wire feed speed at the same level as the welding wire feed speed.* The End wire feed speed provides a destination Amperage or wire feed speed as the welder begins the down slope cycle. **Minimum MIG Wire Feed Speed: 60 IPM**

**Up and Down Slope**

The Up Slope controls the ramp up time from the initial Start Amp/Wire Feed setting to the main welding Amperage/Wire Feed setting. This is set by adjusting the number of seconds, or fractions of a second you wish for the welder to take to ramp up the amperage or wire feed speed. Similarly, the Down-Slope adjusts the ramp down time on the last stage of the weld cycle, which provides time to complete a proper crater fill as the weld begins to cool through the down-slope process as it reaches the final, End Amp/Wire Feed Speed setting.

**2T/4T Control**

The 2T/4T/Finger/Pedal setting controls many functions of the weld cycle such as Pre/Post-Flow, Start/End Amps, and the Up/Down Slope. In TIG and MIG, 2T and 4T modes are used with the torch switch only.

In 2T, the torch switch is designed to start and end the weld cycle very simply. If simple operation is desired, without a foot pedal, select 2T for simple press-and-hold operation of the torch switch. For 2T operation with the torch switch:

- Press and hold the switch to start the arc and weld. Release the switch to cease welding.
- The unit will cycle through the settings that have been preset such as Pre/Post-Flow and Up/Down Slope Automatically when the torch is pressed and released.

In 4T, the torch switch is used as a more complex way of controlling the weld cycle. You can control the individual steps of the arc cycle. Select 4T for advanced use of the sequencer controls on the panel such as pre-flow, post-flow, up slope and down slope. To operate in 4T mode with the torch switch/remote:

- Press the switch to begin the pre-flow and start arc.
- Release the switch once the arc starts and the current will begin to upslope to reach normal welding current.
- Press and hold switch to begin the downslope cycle to fill the crater.
- Release switch to terminate the arc.

In 4T mode, if the puddle becomes too hot, it can be cooled by lightly tapping the switch to begin downslope and tapping again to restart upslope before end current is reached. Setting a long downslope helps improve heat control in 4T as the torch switch is cycled between downslope and upslope before the arc is terminated.

## Discussion of Welder Features and Operation

### SUMMARY OF BASIC FEATURES

#### Foot Pedal/Finger Amp Control (located with the 2T/4T function)

The foot pedal function setting controls AC and DC TIG functions. It starts and ends the arc. It also allows the welding Amperage to be controlled within the range from minimum start/end amps to the maximum welding Amperage selected on the panel. This allows the user to constantly adjust the amperage with the pedal by pressing up and down on the foot pedal similar to an accelerator on a car. The Amperage is infinitely variable within the range. This setting can also be used with the Everlast Slider switch which is available.

The Finger Amp Control Torch function, allows use with a torch mounted amptrol that includes separate buttons for 2T and 4T operation. In this mode the amps can be varied, but the switches dictate the on/off, slope and start/end sequence. This is a rarer use in TIG, but is useful in situations where smooth up slope and down slope cycles are preferred. **This is also used with the Spool Gun to allow the unit to be controlled remotely through the amp control on the MIG gun with a separate switch.**

#### SMAW (Stick) Process

In stick mode the welder delivers a smooth DC low spatter arc. Professional, high-quality welds are obtainable with E7018, 7014, 309L, 316L, 6011 and many other similar rods that are designed for use with any DC stick welder. This unit is optimized for welding E6010. This setting also works well with the easier-welding E6011. The Stick mode also features adjustable hot start time and hot start intensity controls which are designed to help reduce sticking during arc starts while simultaneously reducing porosity or inclusions during arc initiation. **NOTICE:** *This unit does not provide AC operation in stick mode.*

#### Burn Back Control

Burn back control is used to control the length of the wire stick-out after the trigger is released. It helps to prevent the welding wire from sticking in the coalescing weld puddle after the arc is terminated and saves the user from having to trim the wire before restarting the arc.

#### Spot and Stitch Timer

The spot timer function is frequently used in fabrication applications where consistent tack welds are required. This creates a timed arc pulse when the torch trigger/foot pedal is activated. The Stitch timer is used in conjunction with the spot timer to create a regular on/off cycle of the arc while the MIG gun trigger is held to control heat input and to make consistent seam weld during production.

#### Power-Set Mode

The Power-Set mode simplifies the setup process, obsoleting the need for charts and graphs when welding with new filler metals or different diameters of filler. The synergic nature of this mode accepts basic inputs from the user of metal thickness, wire type, wire diameter, filler type, tungsten type etc. (depends upon the process as to which is required) to determine optimum settings for use. This mode does allow for fine tuning the settings to compensate for personal welding preferences and other weld positions. It also serves as the primary method for selecting welding rod type when welding in stick mode. This allows the user to select for E6010 or E6011 performance.

## General Product and Use Information

### MIG/FLUX-CORED WIRE, DRIVE ROLL AND GUN INFORMATION

This unit is designed for multiple types and sizes of MIG and Flux-Cored wire. Recommended wire sizes range from .30" to .045" (.6 to 1.2mm), with the standard equipped 36 series MIG gun. Keep in mind that you may need to purchase optional drive rolls and/or another gun or gun liner to fully utilize and weld with all wire types.

*NOTICE: No one gun can be used for every combination of wire diameter and type. MIG and Flux-Cored drive rolls must be sized for the diameter of wire. Each drive roll typically supports two wire diameter sizes.*

*NOTICE: Small diameter (.023"-.030"/.6-8mm) wires and all Aluminum wires should use a gun that is no longer than 10 ft. (3m) in length, or the wire can jam or feed irregularly.*

For small wire diameter sizes, Everlast recommends purchasing either the 15 or 24 series gun to handle the smaller wire and to give greater flexibility when welding more delicate items. See the information below for more information regarding gun and drive roll selection. *Additional drive rolls to match the wire diameter and type are optional items that may be required. If so, they may be purchased from Everlast.*

- Flux-Cored/Dual Shield Wire: Although the standard gun can be used to weld Flux-Cored wire, it's recommended to use an optional flux-cored gun if much flux-cored welding is to be done to prevent nozzle plugging. If using Dual-Shield, the standard gun is sufficient. You must use *serrated*-groove drive rolls if using Flux-Cored or Dual Shield Wire. Its recommended to only use .030" or greater diameter Flux-Cored wires.
- Stainless (INOX) Wire: Standard Gun and V-groove drive rolls should be used. However, using small diameter (.023"/.6mm)wires will result in problematic feeding without a Polymer liner and a smaller gun (15 Series).
- Steel Wire: Standard Gun and V-groove drive rolls should be used. However, feeding .023"/.6mm wire will require a smaller gun. .030" / .8mm wire will also benefit from using a smaller MIG gun as well, but may not be required.
- Aluminum Wire: There are two options available with Aluminum for this welder. The first option: If using the standard gun, an optional **polymer liner** can be used to smoothly to feed 50XX series Aluminum wire in guns up to 10 ft. in length. (This means the steel liner must be removed and the new polymer liner reinserted in its place.) U-Groove drive rolls must be used to prevent damage to the wire and the gun liner. The gun should be held straight, without coiling or sharp angles. The minimum wire size recommended for this type of feeding is .035" (.9mm) with up to .062" (1.6mm) possible. 40XX series wire is usually too soft for this type of feeding. The advantage of this method is that larger spools of aluminum wire may be used. Never attempt to feed .023" or .030" wire in this fashion. The second option: A spool gun can be used to feed .030" to .045" diameter wire. This limits the spool size to 4", which is typically 1 lb. of Aluminum wire. This is a more expensive, but better option if a longer reach or more convenience is required. Either 40XX or 50XX series Aluminum wire may be fed in this manner. In either case, .023" Aluminum wire should not be used with this welder or feeding problems will result.

*NOTICE: Due to the nature and intent of the Pro-Set function, wire diameter and wire type choices are limited. The Pro-Set function does not incorporate the full range of capacity of this machine. The wire diameter/type choices are designed to accommodate the broadest range of common tasks and is designed to serve as a guide/starting point for users. In 120V mode, wire diameter choices are further limited. The Pro-Set function does not include a Dual-Shield choice. The Flux-Cored Pro-Set function cannot be substituted for Dual-Shield. In manual mode, however, the unit can be used with Dual-Shield by selecting the Flux-Cored function and using the Flux-Cored drive rolls.*

#### **Pro-Set Function Wire Range:**

- Steel: .024" to .035" (.6 to .9mm) (.023" and .025" use .024" selection and drive roll)
- Stainless Steel (INOX): (.6 to .9mm) (.023" and .025" use .024" selection and drive roll)
- Aluminum: .030" to .045" (.8 to 1.2mm)
- Flux-Cored: .030" to .045" (.8 to 1.2mm)

## General Product and Use Information

### MIG/FLUX-CORED WIRE, DRIVE ROLL AND GUN INFORMATION

For smooth wire feeding, free of jamming and slipping, the drive rolls must be sized correctly. You must select the proper type and size of drive roll for the size and type of wire used. The size of the wire and the type of drive roll is marked on the side of each drive roll. On this welder, the groove on the same side of the printed size is the groove that corresponds to the marked size. This means that when installed, the size of the groove will always be facing in. You may need to remove the drive roller to verify the correct groove size is being used. *Only the bottom drive rolls need to be changed. The top drive rolls hold pressure and are flat. The top drive rolls are not removeable.*

The type of wire dictates the groove type:

- Steel and Stainless (INOX) wire uses a V-shaped groove milled into the drive roll. This will be signified by a winged "V" stamped on the side of the drive roll, next to the wire diameter marking.
- Aluminum wire uses a U-shaped groove milled into the drive roll. This will be signified by a U mark stamped on the side of the drive roll, next to the wire diameter marking. This cushions the wire, and prevents scoring and damage for easy feeding when using a polymer type gun liner.
- Flux-Cored/Dual Shield wire uses a serrated groove milled into the drive roll. When viewed from the top, the appearance of the groove is similar to a closed zipper, or saw blade. This also has a zig-zag marking on the side of the drive roll next to the wire diameter marking.

These drive rolls may be stamped in metric wire sizes, or in both metric and imperial sizes. To avoid confusion, use the following conversion to select the proper drive roll for your wire diameter:

- .6mm=.023-.025"
- .8mm=.030"
- .9mm=.035"
- 1.0mm=.040"
- 1.2mm=.045"
- 1.6mm=.062"(1/16")

To change or flip the drive rolls:

- Release the tensioner, by flipping the tensioner down and toward you. The upper drive roll arm should raise.
- Remove the slotted screws securing each lower drive roll.
- Pull each retaining spacer.
- Remove the outer ring of the drive roll and flip the drive roll over or replace it, making note of its size.
- The drive roll is actually made of two pieces. Hold the inner assembly of the drive roll on with one finger (to prevent it from slipping off the shaft), while slipping the outer "rim" of the drive roll off with the other hand. *Both inner and outer parts of the assembly have locating keys. The inner assembly does not need to be removed.*

To reinstall the drive rolls:

- Line up drive roll keyway with the locating key on the inner assembly.
- Reassemble in reverse order and tighten each roller.

*Make sure both rollers are matched in size. Also make sure the locating keys are in place and have not pushed or slipped out of their grooves during assembly. Lightly coat the inner mating surfaces with light machine oil if necessary to prevent future seizure. Do not lubricate the surfaces of the drive rolls or erratic feeding may result.*

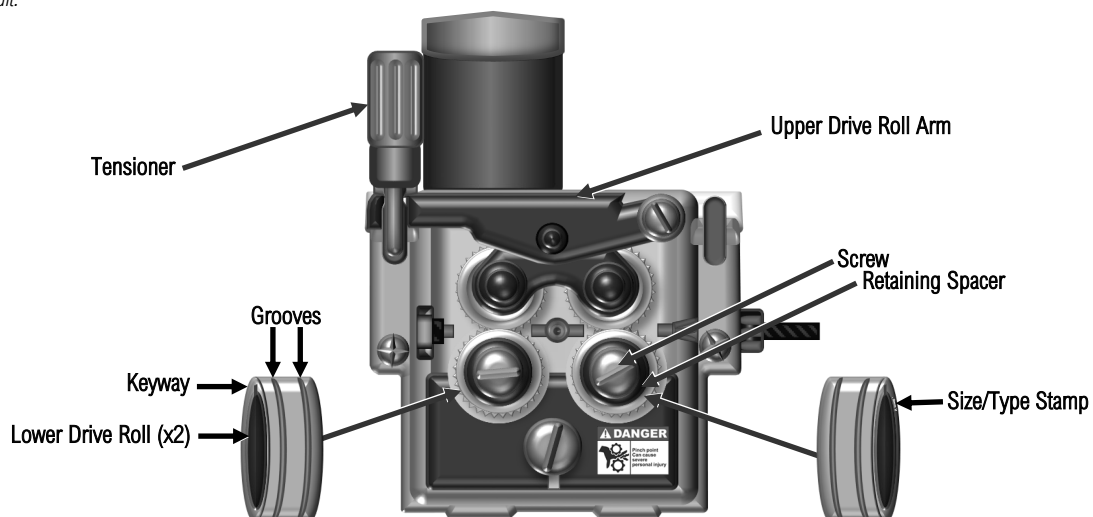

## General Product and Use Information

### MIG/FLUX-CORED WIRE, DRIVE ROLL AND GUN INFORMATION

The MIG gun has a Euro-style quick connect that is used to connect the gun to the welder. This type of connection is the most common throughout the world and most major MIG gun manufacturers can supply any MIG gun in this type of configuration. If you need to change your gun to match other guns in your shop (to keep consumables the same), contact the manufacturer of your preferred gun for a replacement gun with this type of back-end. The Euro-style quick-connect can be rapidly connected and disconnected from the welder without the use of any tools.

To install the MIG Gun:

- Align the pins and the wire pick-up on the torch connector with the holes on the feeder receptacle on the welder.
- Fully engage the connector into the receptacle, wiggling slightly to ensure the fittings seat home.
- Using your hand, twist the plastic hand nut on the gun connector clockwise until it is snug.
- Check for side to side play once more by wiggling it.
- Re-tighten if necessary.

The gun supplied with this unit is an air-cooled 36 Series, 340 Amp gun, design. This gun is a common Binzel®-type gun. This is a widely used gun design and offers excellent ergonomics and dependability.

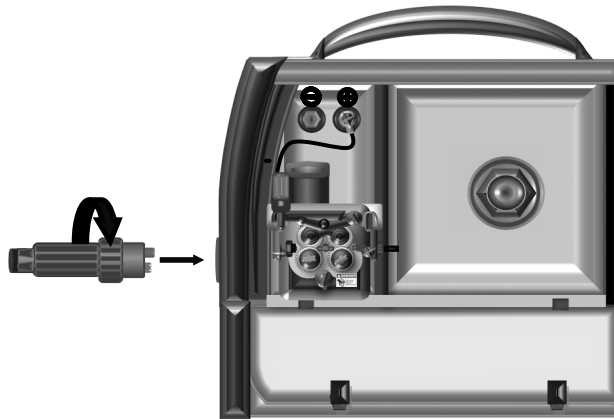

To load the spool of wire:

- Loosen and remove the hand nut on the spool carrier by turning it counter-clockwise.
- Align the locating pin with the hole on the wire spool. *If using an 8" spool slide the adapter on the shaft before sliding the spool on.*
- Slide the spool onto the shaft. Make sure wire is unwinding from the bottom of the spool.
- Adjust de-spooling tension by turning tensioner located under the plastic cap nut on the spool carrier.
- Lightly spin the spool. If it free-wheels more than 1/4 turn, tighten hex nut. If it does not free-wheel at all, loosen tensioner until it free wheels 1/4 turn.
- Reinstall the plastic hand nut so the spool is retained securely.
- Locate the end of the wire and clip the bent end of the wire so that it will feed through the wire feed mechanism smoothly. Carefully hold the spool of wire with one hand so the wire will not de-spool. *Proceed to instructions on the next page regarding feeding the wire.*

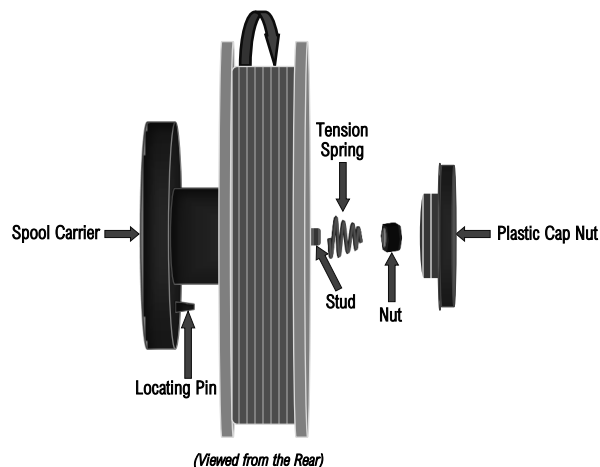

## General Product and Use Information

### MIG/FLUX-CORED WIRE, DRIVE ROLL AND GUN INFORMATION

1. Install the MIG gun as instructed in "To install the MIG gun (torch)" on the previous page. Loosen the top idler roller tensioner, rotating the black tensioner knob counter-clockwise.
2. Flip the tensioner down, toward you, releasing the carrier arm that holds the top drive rolls.
3. Raise the drive roll arm up. Inspect the drive rolls to make sure that each roller's groove size matches the wire diameter. Also make sure correct type of drive rollers are used. i.e. Flux-Core drive rolls use special serrated rolls. (Top driven rollers do not have grooves and are not to be removed).
4. Unscrew the plastic retaining cap from the spool carrier. (See Previous page for more information.) Make sure the spool of wire is loaded correctly so that the wire unrolls from the bottom of the spool (counter-clockwise). Thread the wire into the coiled guide and over the grooves in lower drive rolls. Thread the wire through until it threads into the gun section 4"-6".
5. Reverse the procedure. Begin by lowering the upper drive rolls into contact with the lower drive rolls, keeping the wire securely held down so that it stays in the inner groove of the drive roll. *If needed, use a screwdriver with a fine blade or small pick to keep wire from moving out of the grooves until step 6 is completed.*
6. Raise drive roll tensioner back into place. Tighten it slightly so the wire will be held and not slip out. Notice markings on tensioner for future reference.
7. Remove the contact tip from the torch. Hold the torch cable and gun as straight as possible, in direct line with the unit so feeding of the wire through the gun liner is smooth and easy. Press the gun trigger to feed wire until the wire exits the end of the torch. Reinstall the contact tip over the wire over the wire and tighten it.
8. To prevent bird nesting or slipping of the wire, adjust the tensioner clockwise until the drive rolls will not slip when the wire comes into contact with a hard surface. The wire will curl up on end while feeding under power. If you over-tension the wire, you will increase the chances of bird nesting of the wire (balling up of the wire or curling of the wire around the drive rolls), so it is best to tighten just until wire stops slipping and is able to curl up. Extra tension can deform the wire and prematurely wear the drive rolls. Slowing of the feeder may result as well. Remember not to test on any metal attached to the work clamp to prevent the wire from arcing while performing this test.

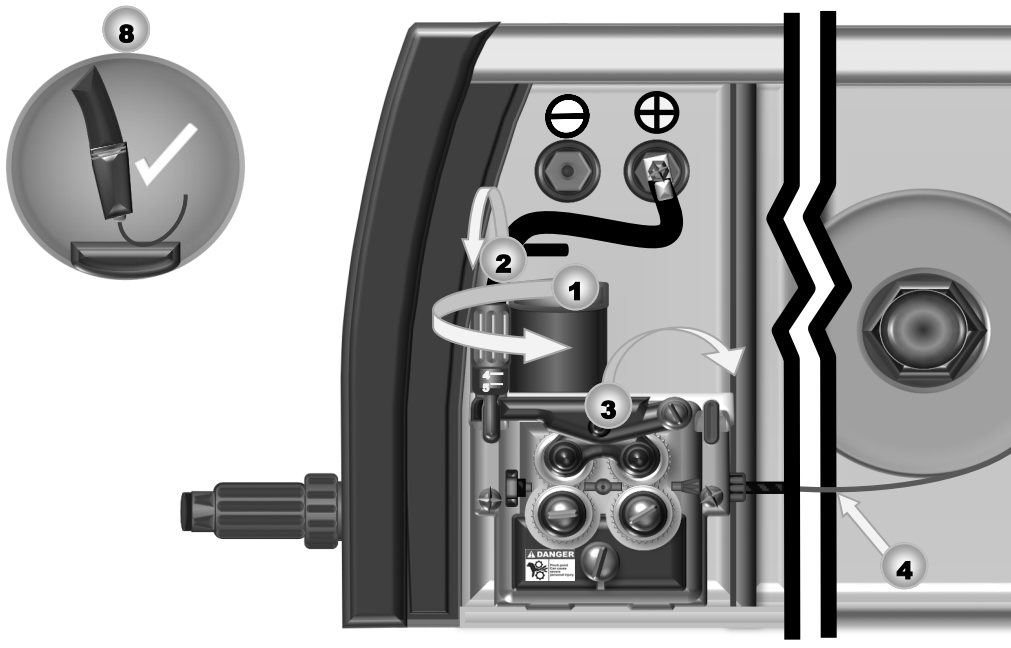

#### WARNING!

The wire feeder has moving parts and has pinch points. Keep all guards in place during use or serious injury may occur. Make sure all drive rolls are tight and the wire is properly tensioned. Over tensioning can create jamming and wrapping of the wire around the wire feeder. Keep cover closed while feeding wire.

## General Product and Use Information

### NOTICE:

The Lightning MTS 275 uses two gas connections. One connection is for MIG operation and the other is for TIG operation. Two cylinders may be connected at the same time. Only one regulator is supplied, but an additional regulator may be purchased. If only one cylinder is used, or no connections are being used, the open fitting(s) should be plugged or covered to prevent dirt and debris from entering the fittings. Use a rubber cork, or hydraulic fitting cap to keep the fitting covered. Failure or sticking of the gas solenoids is typically caused by dirt or debris entering the system. Although the solenoid may be disassembled and cleaned to restore normal operation in most cases, extreme dirt and contamination will damage the solenoid(s), necessitating replacement.

### CONNECTING THE GAS TO THE CYLINDER:

To safely connect the regulator to the cylinder, first make sure the cylinder is properly chained and secured. Then, before connecting the regulator and while standing to the side of the discharge (not in front of the discharge), briefly crack the valve and allow a 1 to 2 second blast of gas to clear any dirt or contamination from the valve seat. Then connect the regulator and screw the fitting clockwise until finger tight and finish tightening with one 1 1/8" wrench. Do not use a pair of pliers or other grip/lock devices. Use a large adjustable wrench if no other wrench is available. Make sure the connection is tight. Slowly open the valve to check the connection for leaks with luke-warm soapy water (or approved leak detector solution) applied to the fittings at the valve.

To connect the hose to the rear of the unit, screw the 5/8" gas fitting into the gas inlet on the rear of the unit, rotating clockwise until finger tight. Then use two (2) 3/4" wrenches to complete the tightening process. One wrench should be placed on the female gas inlet nut and should be held tightly to while the other wrench is used to finish tightening the male fitting. **Always tighten the connection at the welder using one wrench to hold the welder inlet fitting and another wrench to tighten the regulator hose fitting. Using only one wrench may result in damage to the fittings.** Check all fittings and connections for leaks once again. *See illustration next page for proper connection arrangements.*

Do not use thread tape or sealant on threads of the unit, regulator or cylinder. Plugging and sticking of the gas solenoid valves, regulator or torches may occur if thread sealants are used. The compression fittings used will tighten up once proper pressure has been achieved. If the cylinder will not seal, the threads may be worn on the valve. If hoses show sign of leaks, tighten the clamps with a pair of side cutters or end nippers. Gently squeeze the clamp tight until the leak stops or add an additional clamp only if absolutely necessary. If the regulator leaks, remove it from service.

### REGULATOR ADJUSTMENT

The Ball valve will float briefly once the main cylinder valve is opened and will then settle down and stop floating after 4 to 5 seconds. Fully open the cylinder when in use to prevent valve leaks. If the valve continues to float, you have a leak. Stop and check. To adjust the gas flow rate, the welder must be turned on. Select MIG or TIG and set post flow to maximum. Gas flow is actuated by quickly tapping the trigger on the torch (or pedal). The small knob on top of the down tube that connects to the hose adjusts gas flow rate. Screw the knob counter-clockwise to increase flow. This meter will work with both Argon and Argon/CO2 mixes. The flow rate is calibrated in Cubic Feet per Hour (CFH). (Markets outside of North America may be calibrated in Liters per Minute (LPM)). The pressure gauge only registers the pressure inside of the gas cylinder. The clear plastic tube determines actual flow rate. As the cylinder loses pressure near the end of its contents, flow rate may need to be readjusted. This is normal. Read the flow rate of the gas at the middle of the floating ball.

### WARNING!

Never attempt to repair a damaged regulator yourself. The parts are under pressure. Serious injury or death may occur. Do not open the cylinder valve quickly or damage can occur to the regulator.



## General Product and Use Information

### Gas and Electrical Connections

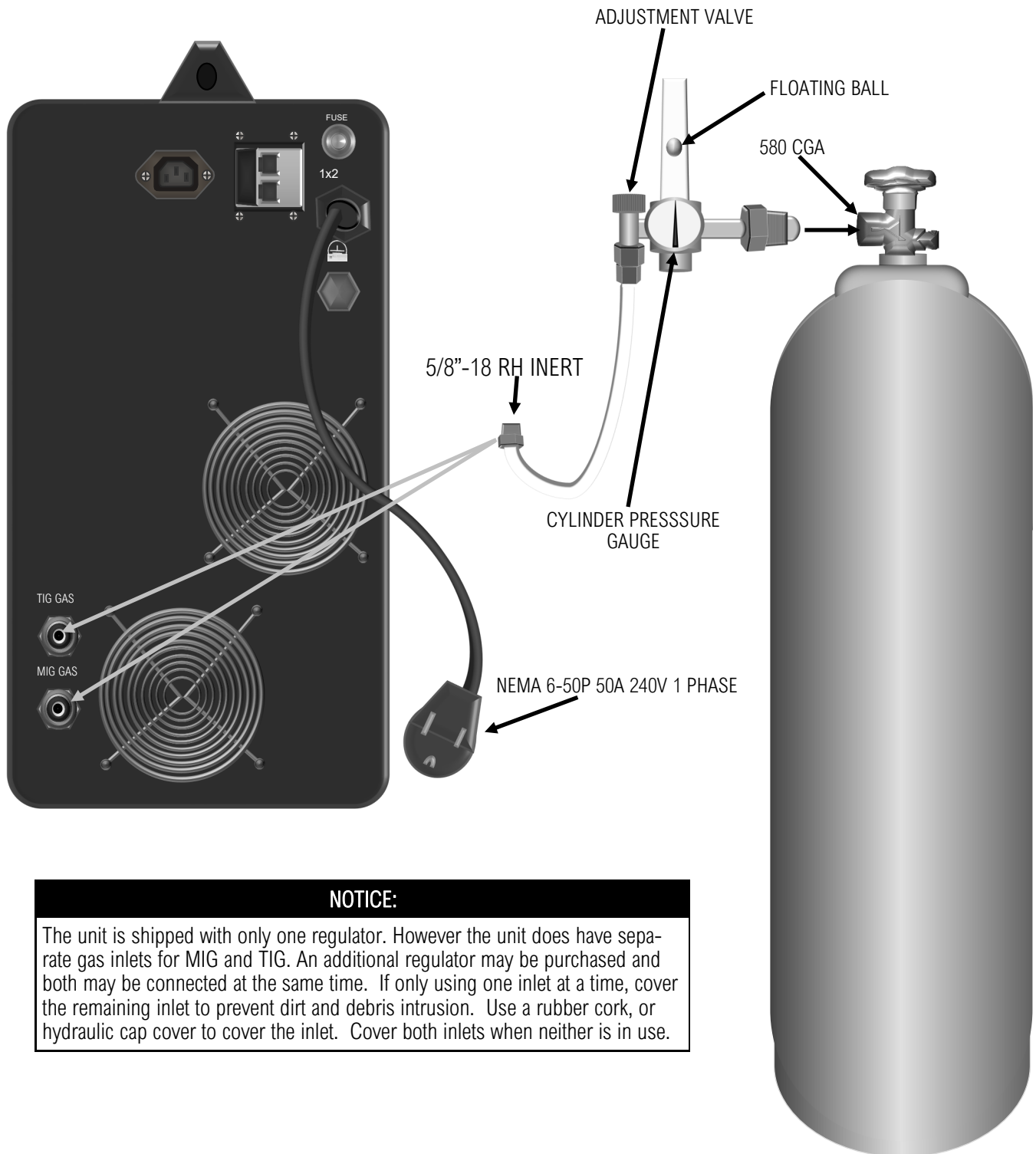

#### NOTICE:

The unit is shipped with only one regulator. However the unit does have separate gas inlets for MIG and TIG. An additional regulator may be purchased and both may be connected at the same time. If only using one inlet at a time, cover the remaining inlet to prevent dirt and debris intrusion. Use a rubber cork, or hydraulic cap cover to cover the inlet. Cover both inlets when neither is in use.

## General Product and Use Information

### GAS SELECTION

Gas selection for different processes can be confusing. The unit has preset selections for gas type and recommendations for gas in the reminder screen that pops up for a few seconds when a new process is selected. These guides help you remember which gases should be used. However, for MIG, they are not absolute. This is particularly true of the MIG Steel C25 and MIG Stainless Mode, unless it is being used in Pro-Set mode. In the Pro-Set mode the suggested gas must be used to obtain workable and accurate settings. The suggested gases for MIG are based upon standard, short-circuit mode and do not take into account the axial spray mode. See below for the stated Gas modes and alternate (permissible) gases that can be used.

- TIG (Steel Stainless): Recommended: 100% Argon; Permissible: He/Ar mix, no more than 25% He
- TIG (Aluminum): Recommended 100% Argon; Permissible: He/Ar mix, no more than 25% He
- Stainless MIG: Recommended: 98/2 Ar/CO<sub>2</sub>, Permissible: Tri-Mix (for short circuit only)
- Steel MIG C25: Recommended: 75/25 Ar/CO<sub>2</sub> (for short circuit); Permissible: 90/10, 80/20, 95/5 Ar/CO<sub>2</sub> (All gases 80/20 and above are considered to be gases used for axial spray.)
- Steel MIG: C100: Recommended: 100% CO<sub>2</sub> (for short circuit); Permissible: No other gas.
- Aluminum MIG: Recommended: 100% Argon; Permissible: No other gas.

### WARNING!

Do not leave the regulator on when not the welder is not in use or loss of cylinder contents may occur. Loss of cylinder contents may result in asphyxiation since the shielding gas is heavier than air and does not dissipate quickly. Always have enough ventilation. Do not weld in tight, closed spaces for extended periods of time.

### ADJUSTING GAS FLOW RATES:

The gas flow rates for TIG and MIG welding are critical for creating a good, contamination and porosity free weld. Too much flow rate will create turbulence and introduce air to the weld. It may seem counter-intuitive, but solving issues with gas coverage by steadily increasing gas flow can create more problems than it solves, and can actually mimic the same issues observed by too little gas flow. In general, ideal gas flow will vary and no one gas flow rate is perfect for every situation. Gas flow rates for MIG are usually 20 to 30% higher than the gas flow rates used for TIG. However, when adjusting gas flow, keep in mind the following variables:

- Joint Design/Type
- Nozzle/Cup Size (Larger cups require more gas flow. TIG Gas lenses offset the increased demand of larger cups.)
- Metal Type (Aluminum typically requires higher rates, especially in MIG.)
- Welding Position (Flat position usually requires less gas flow.)
- Air Circulation Around the Weld Area (TIG is more sensitive.)
- Gas Type (Gases with Helium require higher flow rates.)

The best method for setting gas flow rates involves trial and error by welding, observing the weld and stopping to make quick gas flow adjustments.

*To properly set gas flow in MIG or TIG modes:*

- *Start by setting the gas flow rate to 20 CFH. This will get you close to where you need to be in most cases.*
- *Lower the gas flow rate, 2 CFH at a time. Do this until bubbles and porosity, and extra soot are noticed in and around the weld (for TIG and MIG) and tungsten (for TIG only) is not shiny.*
- *If bubbles and porosity are present at 20CFH, proceed directly to the next step.*
- *Slowly raise the gas flow rate 1CFH at a time until the bubbles and porosity disappear from the weld.*
- *Once the porosity and gas disappear, add another 1 to 2 CFH to allow a buffer zone of gas flow. This will minimize gas wasting and prevent issues caused by too much gas flow. The weld should be bright and shiny if the metal was properly prepped, gun/torch angles were correct etc.*

*For Aluminum MIG welding, extra gas flow is required. Start this process around 30 CFH.*

## CONNECTIONS AND POLARITY

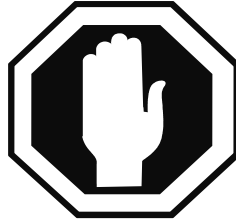
**STOP!****IMPORTANT!**

Read the information on this page and the following pages carefully. It contains important information on correct polarity of your torches and guns for all processes. Failure to follow these directions can lead to damage to your welder. **Damage occurring from improper polarity may not be covered under warranty.**

**⚠ CAUTION!**

Pay attention to the separate DC and AC TIG connections. The AC connector is designed for use in TIG mode only and serves as the work clamp connection in AC mode. (Stick mode does not provide AC output.) Even if you switch the machine to AC, you will still need to move the work clamp cable to the AC output terminal connector. The TIG torch will always remain in the negative (-) connector. Remember to switch the work clamp back to the positive (+) connector when reverting to DC TIG operation. *Failure to change the connector and trying to weld with this configuration may damage your unit.*

**⚠ CAUTION!**

Remove TIG and Stick torches and controls while MIG welding. **These connections remain live and can cause the torches to short out against any metal that comes into direct contact.** The MIG gun may remain connected while welding TIG or stick but the nozzle must be insulated from contact. A small rubber hose or non-conductive tubing may be slid over the tip of the gun to protect it if needed. *Do not attempt to MIG weld, Stick weld or DC TIG weld with the work clamp in the AC port. Damage may occur! Check the polarity before welding, especially if a another process was recently used.*

**POLARITY CONNECTIONS**

PROCESS	TORCH POLARITY	WORK POLARITY
MIG (GMAW)	+	-
FLUX CORED (FCAW)	-	+
STICK (SMAW)	+	-
DC TIG (GTAW)	-	+
AC TIG (GTAW)	-	AC

**IMPORTANT!**

Always connect the work clamp directly to the part being welded. Avoid connecting to table tops or bench legs or indirectly through other items if possible. Loss of power and or poor arc starting may result. This is also a primary cause of a wandering or unstable arc. Keep work leads in good condition.

## CONNECTIONS AND POLARITY MIG (GMAW)

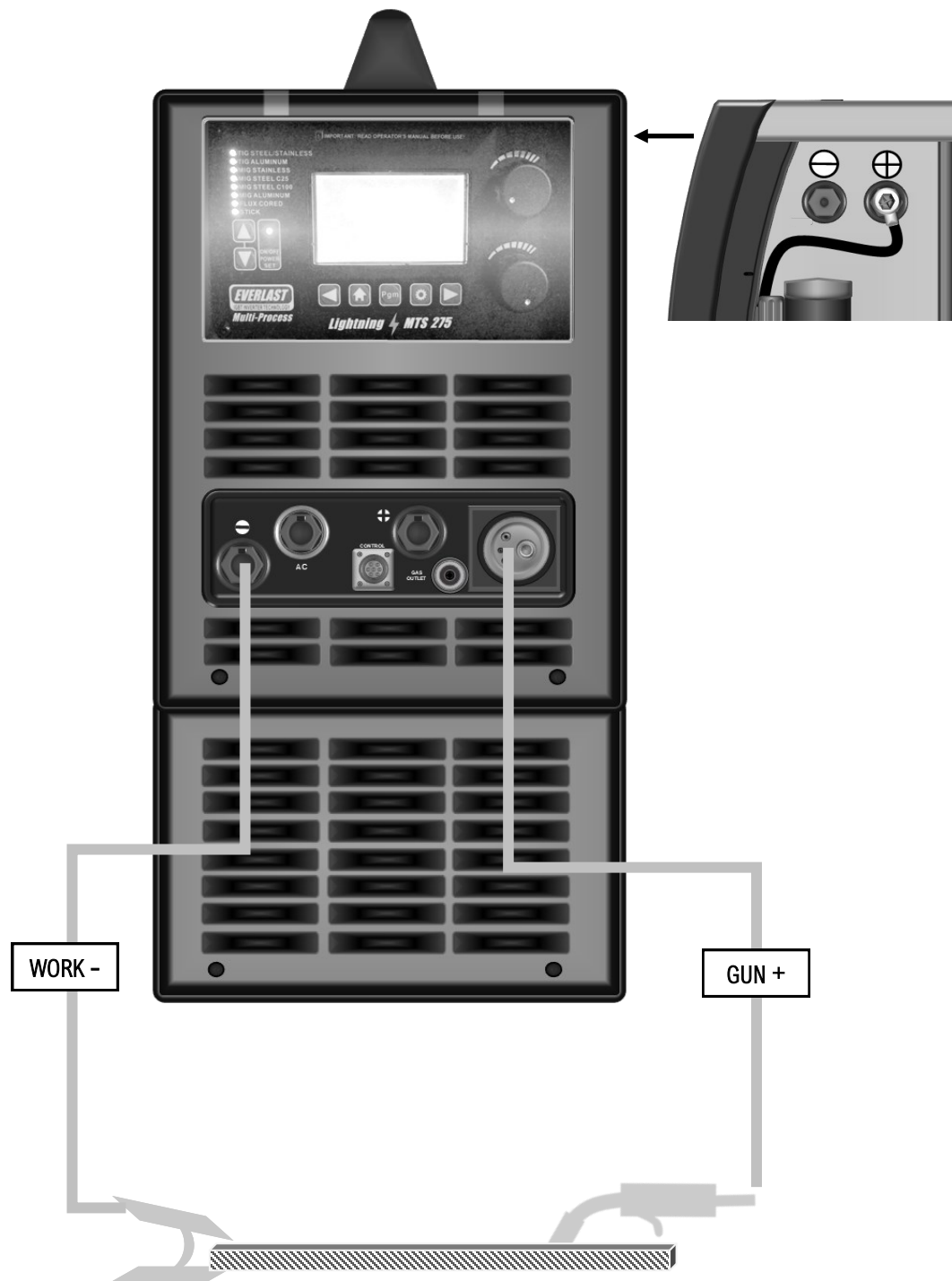

### NOTICE:

For MIG, the polarity connection for the gun is located under the spool cover. It must be connected to the positive terminal. MIG requires that the gun be positive polarity and the work clamp be negative polarity.

## CONNECTIONS AND POLARITY Flux-Cored (F-CAW)

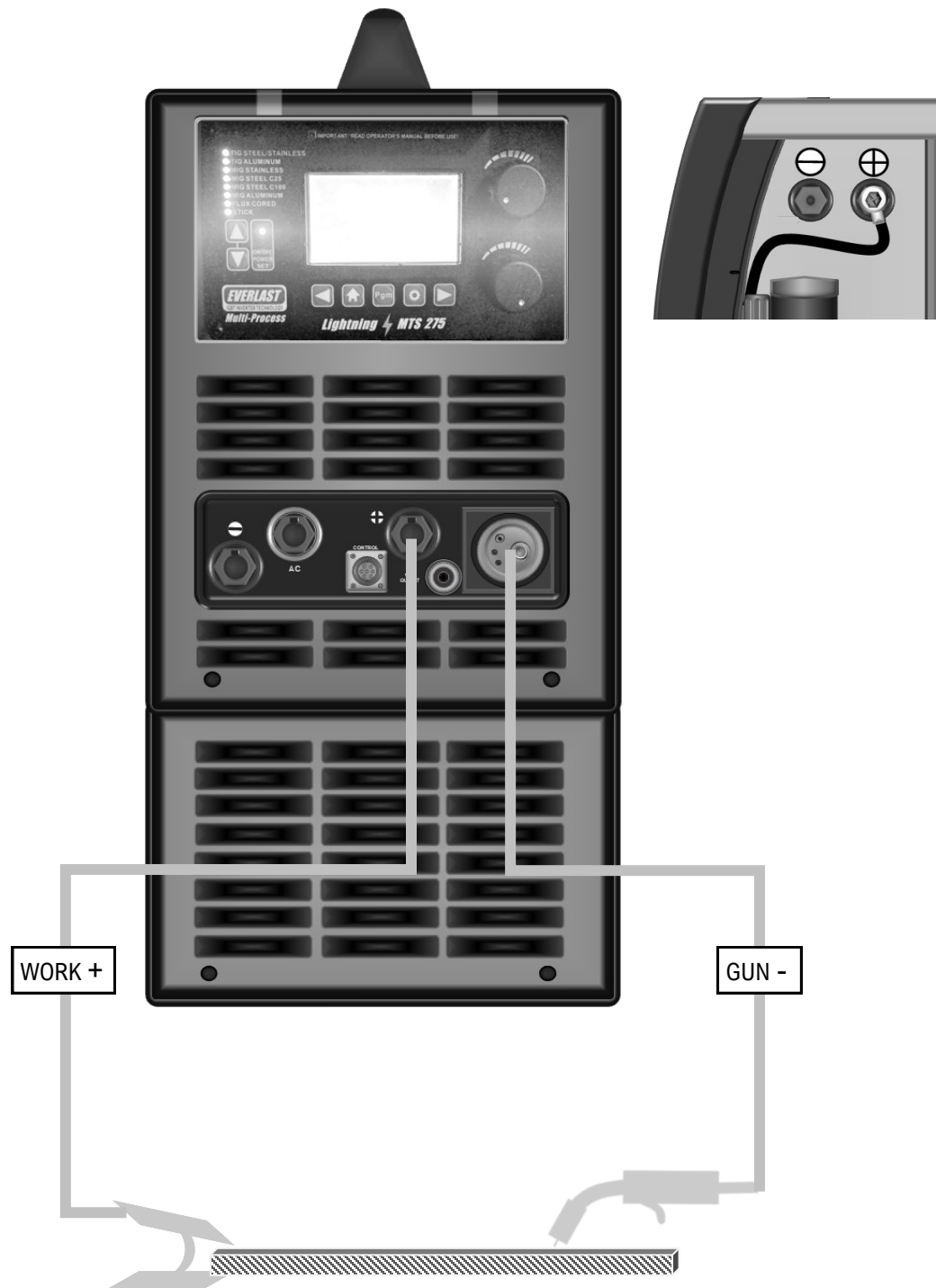

### NOTICE:

For Flux-Cored, the polarity connection for the gun is located under the spool cover. It must be re-located to the negative terminal. Flux-Cored requires that the gun be negative and the work clamp be positive polarity.

## CONNECTIONS AND POLARITY MIG (GMAW) with Spool Gun

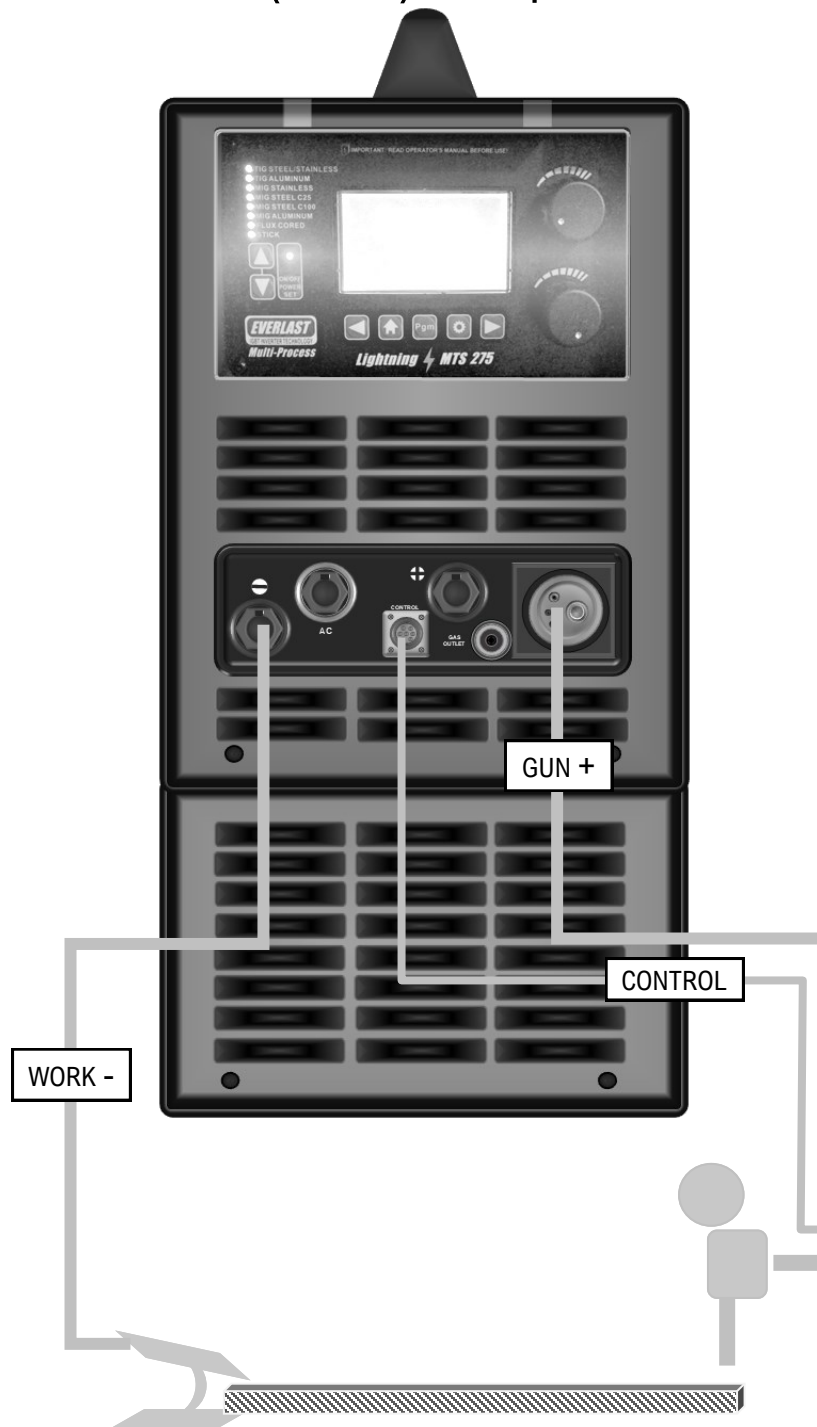

### NOTICE:

The polarity connection for the Spool gun is located under the cover. The gun polarity should be positive. If welding Flux-Cored wire with the spool gun, use the negative terminal, and configure for Flux-Cored use.

## CONNECTIONS AND POLARITY DC TIG ONLY! (GTAW-DC)

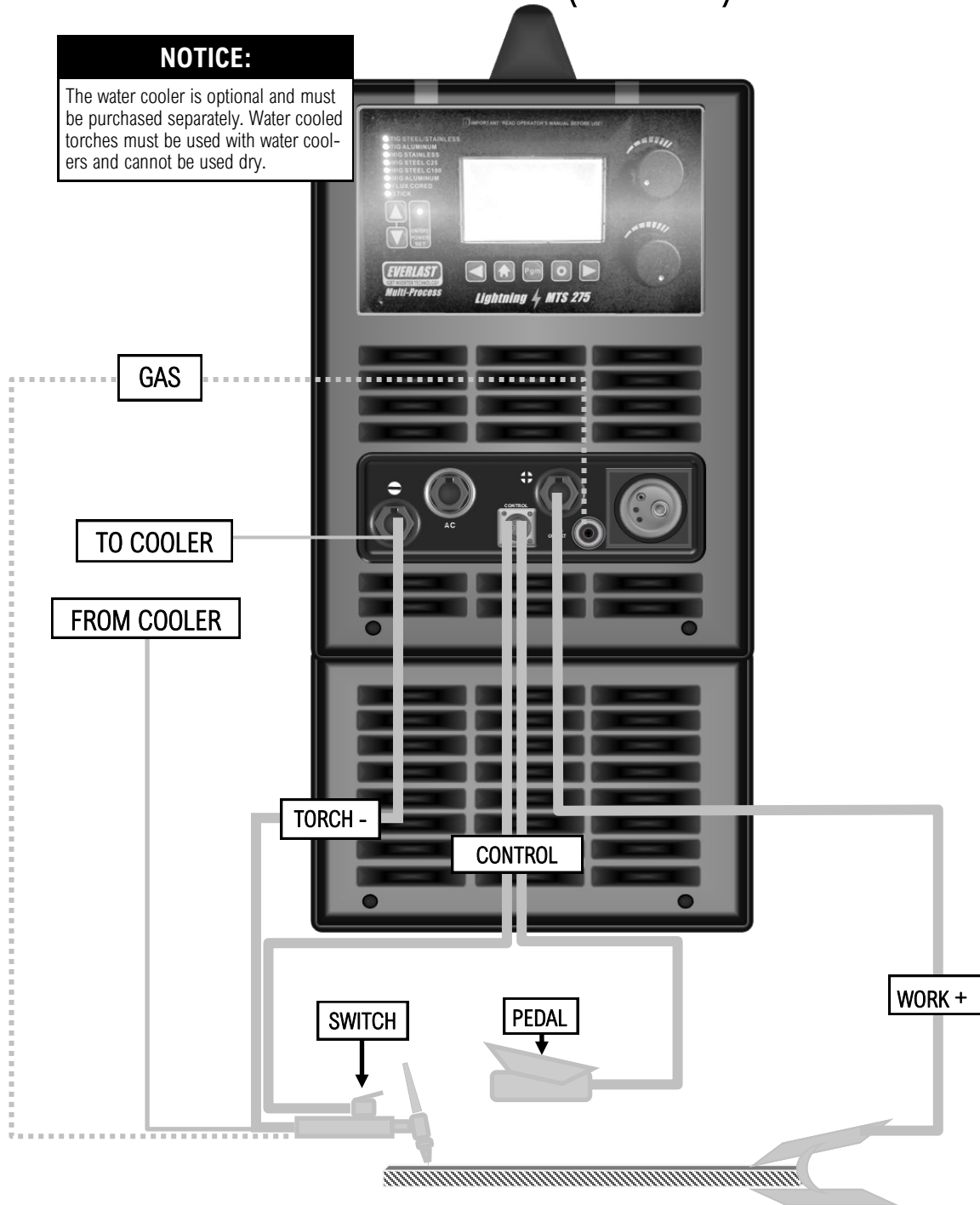

**NOTICE:**  
The water cooler is optional and must be purchased separately. Water cooled torches must be used with water coolers and cannot be used dry.

**NOTICE:**  
The foot pedal and the torch switch cannot be connected at the same time. The torch switch may remain attached to the torch, but since they both use the control connection and serve a similar purpose only may be used at a time. The torch depicted is a water-cooled torch and the diagram depicts proper connection for water-cooled torches. Do not use this torch without a water cooler or torch damage will occur. To determine the gas line blow through the lines with compressed air. Improper connection will result in no gas flow or water coming out of the torch head. The Everlast Coolers are designed to be powered from the 240V plug in the rear of the unit. Use only TIG rated coolant in the cooler.

## CONNECTIONS AND POLARITY AC TIG ONLY! (GTAW-AC)

**NOTICE:**  
The water cooler is optional and must be purchased separately. Water cooled torches must be used with water coolers and cannot be used dry.

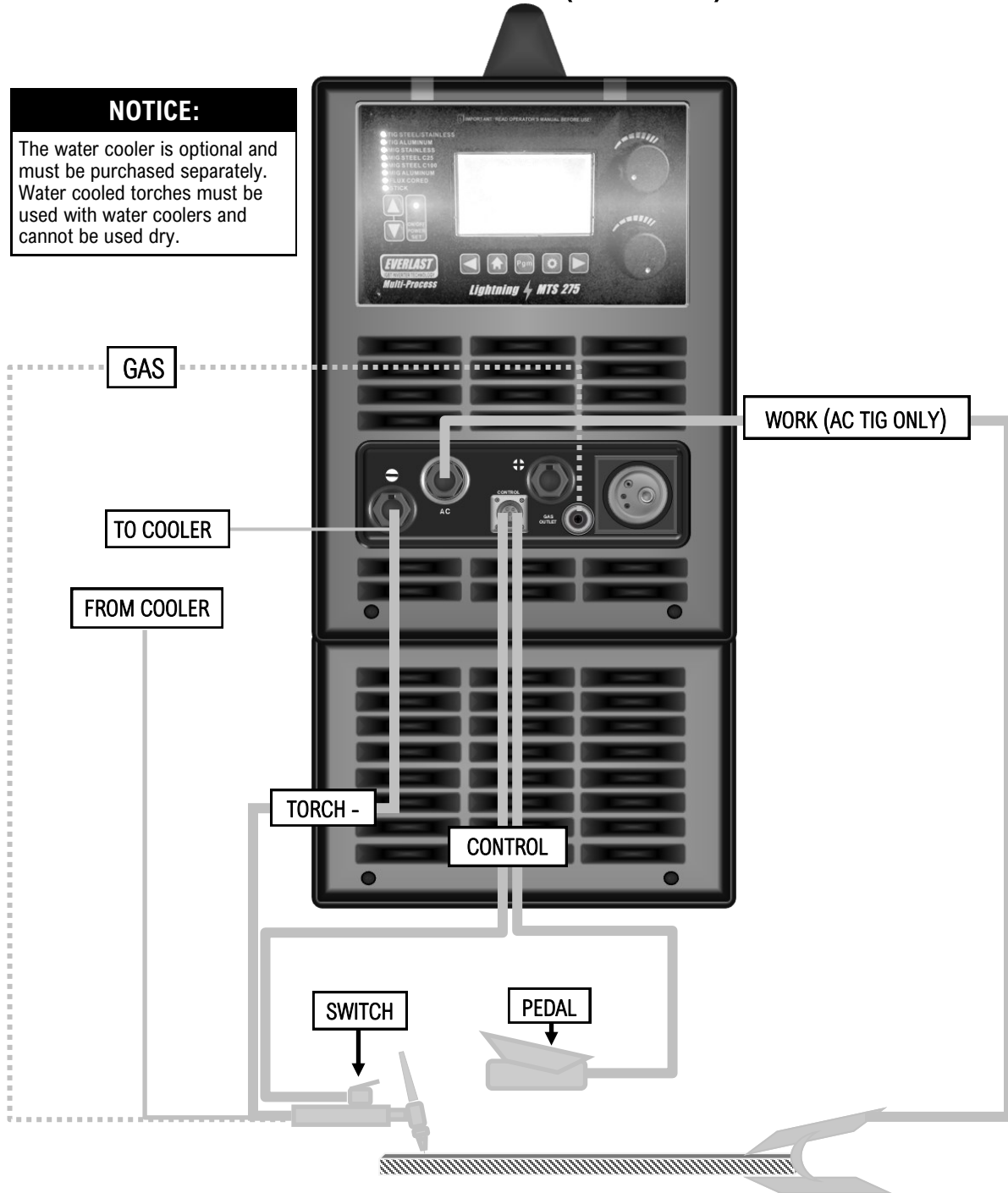

**NOTICE:**  
The foot pedal and the torch switch cannot be connected at the same time. The torch switch may remain attached to the torch, but since they both use the control connection and serve a similar purpose only may be used at a time. The torch depicted is a water-cooled torch and the diagram depicts proper connection for water-cooled torches. Do not use this torch without a water cooler or torch damage will occur. To determine the gas line blow through the lines with compressed air. Improper connection will result in no gas flow or water coming out of the torch head. The Everlast Coolers are designed to be powered from the 240V plug in the rear of the unit. Use only TIG rated coolant in the cooler.



## CONNECTIONS AND POLARITY Stick (SMAW)

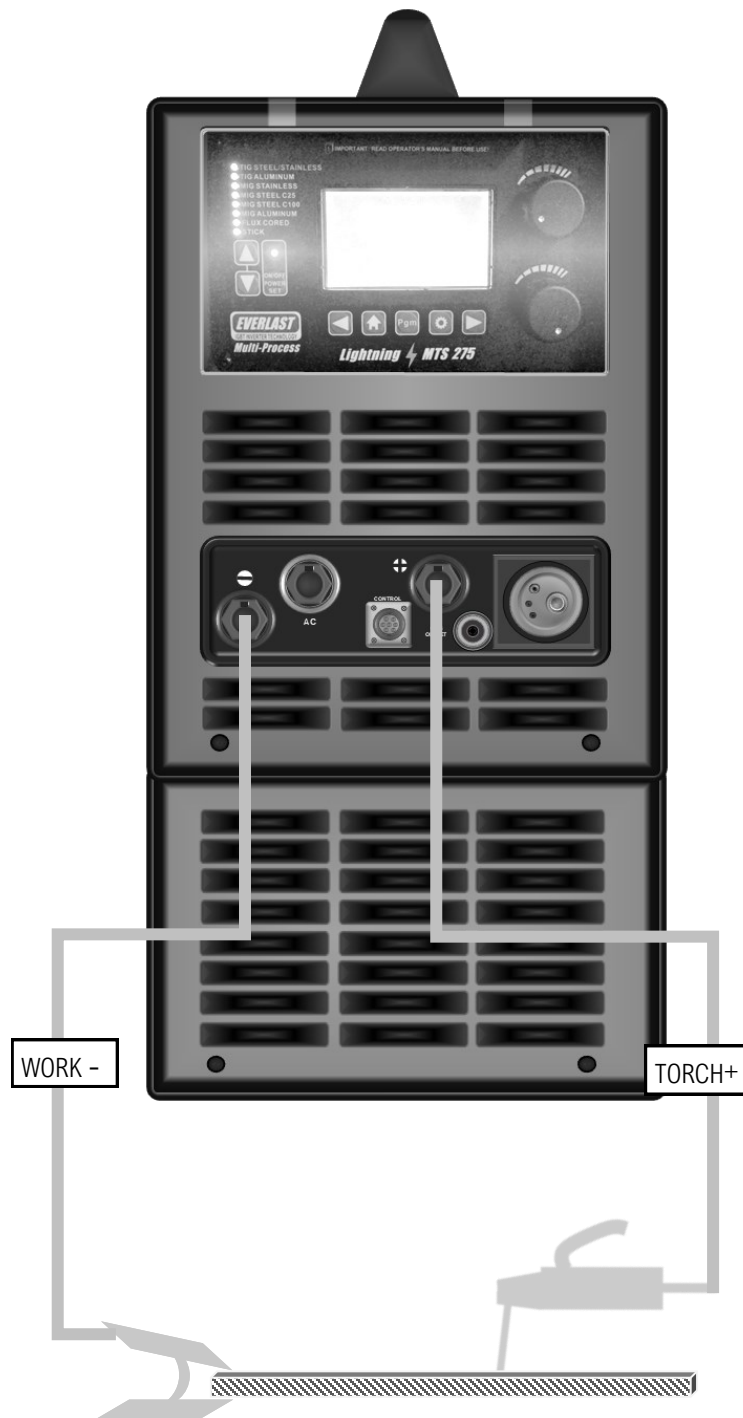

### NOTICE:

This is the typical setup for stick welding. Most all welding electrodes use electrode positive as the preferred polarity. Some rods are designated for both polarities. Consult the electrode manufacturer's recommendations for applications of EN or EP. Operation with old or improperly kept welding electrodes will affect performance. If difficulty is encountered welding with a particular class of rod, try changing to another brand.

## SETTING UP WELDING PARAMETERS

### PANEL CONTROLS AND NAVIGATION

#### GENERAL OVERVIEW OF MANUAL SETUP

This welder has an user interface that has been carefully designed to reduce needless steps and eliminate hidden menus where ever it is possible. The key feature that was most important during the design process, was to mimic the feel of an analog machine, where most all settings are visible at a glance. This has been achieved by sectioning the display screen into pin-wheel arrangement of the most all of the parameters associated with selectable and adjustable values. Each parameter in the pinwheel display also displays the value of that parameter. For example, if the Post Flow has been set to 5 seconds, the 5 second value will show in the Post flow section of the pinwheel. Using a far left/ far right arrow buttons under the display screen allows the user to rotate through the pinwheel and highlight the desired parameter, allowing it to be adjusted. As the user rotates through the parameter menu pinwheel, the selected segment will turn from green to red. When a pin wheel segment is highlighted, the value may then be increased or decreased with the top adjustment knob.

In some cases a secondary menu is required to select or change a status (turn function on or off) of a function/parameter located on the pin wheel. Once the function is highlighted in the pinwheel menu, the settings (gear shaped icon) button can be pressed to access it. For example, when selecting AC Wave form in the AC TIG mode, the ON/AC segment should be highlighted, and then the settings button will be pressed. This will bring up a secondary, 4 way square menu, where you can select the desired wave form, and also select and set the value of AC Frequency and Balance with the left and right arrows, and top and bottom knobs. The 4-way menu may or may not use all 4 squares, depending upon the function selected for adjustment.

The final step is to complete the setup process by pressing the home (house shaped icon) button, which returns the program back to the main pinwheel menu where welding can begin or other parameters may be selected for adjustment.

If you become lost or forget how you came to a certain menu screen, simply pressing the home (house shaped icon) button at any time will return the programming back to the main pinwheel menu.

The Pgm (Program) button allows you access directly to the Save menu so that settings can be retained for future use.

**SAMPLE PINWHEEL MENU**

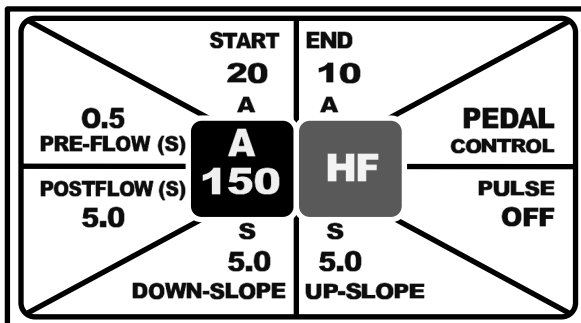

**SAMPLE 4-WAY/ SECONDARY MENU**

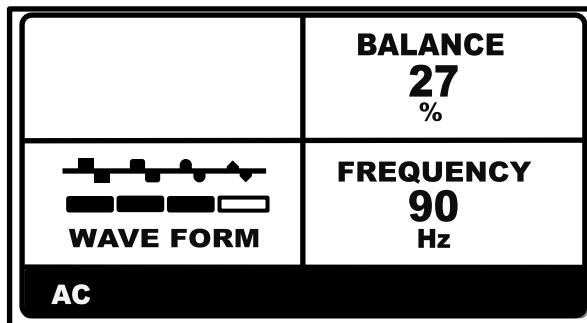

## SETTING UP WELDING PARAMETERS

### PANEL CONTROLS AND NAVIGATION

#### GENERAL OVERVIEW OF POWER-SET FUNCTION

The Power-Set function has been designed to be a predictive setting guide for the beginner and professional seeking easy, straight forward, no-hassle setup for many welding applications. The Power-Set function can be used to suggest useful settings for DC TIG (Steel/Stainless, Titanium etc.), AC TIG (Aluminum), Steel MIG with 100% CO<sub>2</sub>, Steel MIG with 25% CO<sub>2</sub>, Stainless Steel MIG with Tri-Mix (short circuit only), Aluminum MIG, Flux-Cored, and Stick.

To operate the Power-Set mode, the user must input basic information concerning the process.

The user will be required to input information (depending upon the process being used) about Filler metal type, metal (weldment) thickness, Filler metal diameter, Electrode type and class. These will be displayed on a menu that is different than the pinwheel, or 4-way menu. *The Power-Set menu is represented by a X shaped menu as shown in the samples below.*

The Power-Set mode provides the user with a recommended or “target” volt and/or amp setting indicated by the 4 cornered star in the middle of the horizontal bar. It also provides a limited range of adjustment for fine tuning for the application or conditions. The goal of this is to prevent user from guess and experiment with settings to achieve a “workable” setting, while simultaneously preventing you from straying too far from acceptable operating parameters.

The Power-Set function is no better than the accuracy of the input from the user. Selecting the wrong process or the wrong wire diameter, for example, will lead to poor or unpredictable performance. Always be sure of the correct wire type, diameter, electrode type, metal thickness and process type before using the Power-Set mode.

**NOTICE:** While Power-Set mode is engaged, most functions such as pre and post flow, inductance etc. are locked down and cannot be adjusted. However, this does not keep you from making adjustments to these additional parameters. The necessary “background” parameters should be adjusted before entering Power-Set mode. The background changes will carry over to the Power-Set mode and will be locked-in during the Power-Set welding session. If additional adjustment is needed to any of these background parameters while in Power-Set mode, you must drop out of the Power-Set mode temporarily to make the necessary changes, and then the Power-Set mode can be re-engaged.

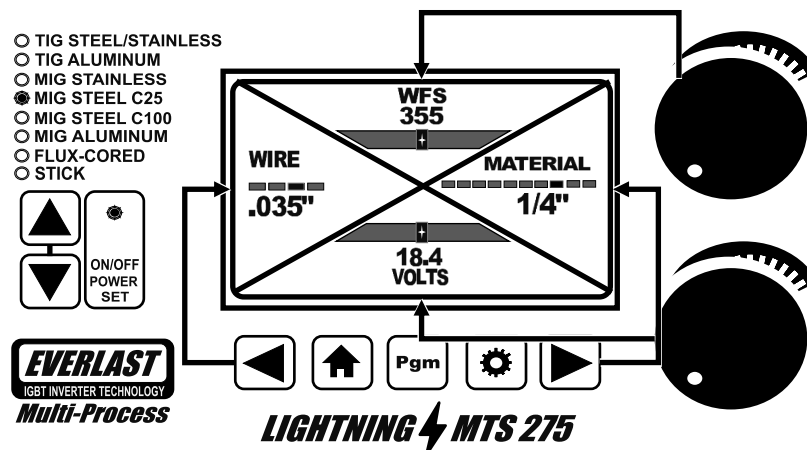

#### IMPORTANT!

Although the unit can operate safely from 208 to 240V input, Inputs of 220V and lower may affect the accuracy and performance of the Power-Set mode. This can be compensated for by increasing or decreasing the target values. Similar issues can occur when operating on 120V, where voltage drops to 110V or lower.

# SETTING UP WELDING PARAMETERS

## POWERING UP THE WELDER

### BOOT SCREEN MENU

When the unit is turned on, the unit will display a boot screen similar to the one above while it is powering up and determining the input voltage. All the LEDs should be lit as well. This will take a few seconds, and then it will default to indicate the last used process in the vertical LED array. The reminder screen will appear briefly before automatically advancing to the pinwheel shaped parameter menu for the process.

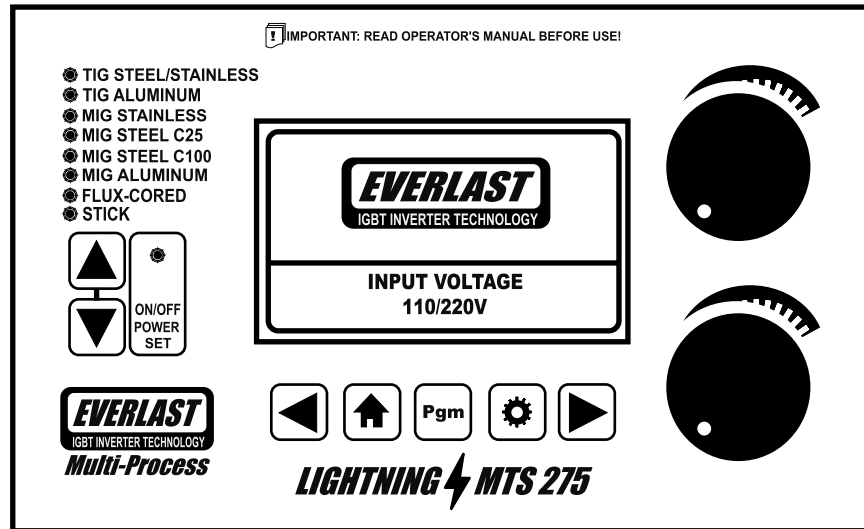

### NOTICE:

In all processes, the maximum output is limited in 120V mode. In the Power-Set mode, the selection choices for some of the user inputs will be limited. Not all wire sizes, metal thicknesses etc. will be offered due to the output limitations of 120V operation.

### PROCESS SELECTION







Once the boot screen menu has cleared, use the process selection arrows to toggle up and down to select the desired welding process. When a new process is selected, the unit will display a reminder screen with information to confirm the welding process selected. It will also suggest the required welding gas, if any. Each process will have a similar screen to the one below.



## SETTING UP WELDING PARAMETERS

## PANEL CONTROLS AND NAVIGATION



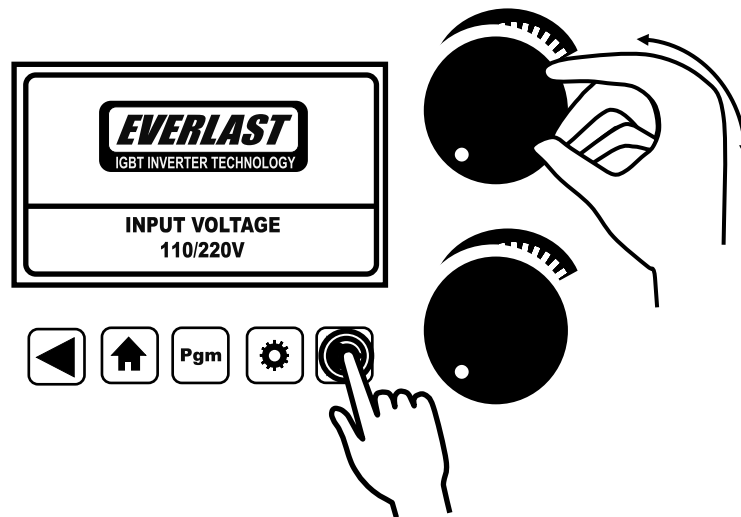

## NAVIGATION AND ADJUSTMENT SUMMARY

Although it may take a little practice at first, the navigation of the screens and menu are fairly straight forward. The left  and right  (arrow) buttons located below the screen will always navigate around the pin wheel menu or 4-way menu Screen. In Power-Set mode, arrow buttons are used to select filler size/type, or metal thickness and only navigate the X segment closest to the button. The  (settings) button is pressed to access the 4-Way Menu. This is a second level menu that allows access to other screens to select function status (on/off or different operation style such as 2T/4T/Pedal/ Finger etc.) or select or adjust less commonly needed parameters of the selected function on the pin wheel menu. The  (home) menu button will always return the unit to the main pinwheel screen and make the welder ready for welding. The top  right knob adjusts the value of a highlighted parameter, or the top parameter in the Power-Set mode. The bottom  right knob is used less often in manual mode. When it is used, it is used to adjust Voltage, AC Frequency or the bottom parameter in the Power-Set mode.

The  (Program) button is used to access and save programmed settings.



## NOTICE:

The  (home) button and the  (settings) button are inactive in the Power-Set menu. The  (left arrow) button controls only the left input segment in the Power-Set mode. The  (right arrow) button controls only the right input segment in the Power-Set mode.

# **TIG STEEL/STAINLESS (DC TIG)**

## UNDERSTANDING DC TIG FUNCTIONS

### TERMS RELATED TO DC TIG FUNCTIONS

**Arc Start Type.** There are two basic forms of Arc starting that may be selected in manual mode, The user may select from either High Frequency (touchless) arc starting or Lift Start (Lift Arc) . High Frequency start sends an HF impulse to the torch tip to jump the gap between the Tungsten and the workpiece which establishes a circuit path for the welding arc to follow and ignite. Lift Start which uses the torch switch or foot pedal to send a low current to the Tungsten tip. Once the tip of the Tungsten is touched quickly to the work and raised up in a seamless motion, the welder senses the contact and sends full current through to the tip as it breaks contact with the work, igniting the arc. (See instructions on TIG arc starting later in this manual.)

**Amps. (A)** Amps are the measurement of the “pressure” of the electricity. Depending upon wave form, the display may read lower while welding than what is set, because the hall effect sensor measures and reports the average Amperage of a wave form, and not the peaks. This includes Pulse Amperage as it reports an average Amp value. Changing the Wave-form or Changing the Pulse settings affects the average Amperage. **NOTICE:** *When the foot pedal mode is activated, the unit will display selected maximum Amperage for a few seconds before defaulting to display the minimum welding Amperage. This is because the Amperage signal at the foot pedal is at the minimum position. When the foot pedal is pressed, or the torch slider is increased, the display will continue to reflect the Amperage dictated by the position of the pedal/slider. To recall the selected maximum Amperage, tap briefly on the pedal, or slightly rotate the top right control knob. In 2T or 4T mode, the selected amperage will continue to display until the arc is struck. After that the Amp display displays actual amp output, which may vary slightly from the preset Amperage.*

**Control.** The Control setting governs the function of the torch switch and foot pedal. The control offers several modes which include 2T, 4T, Pedal, 2T Finger and 4T Finger. The Pedal mode allows the unit to be controlled by the foot pedal or a torch slider or similar amptrol. 2T mode and 4T mode offer two modes used with the torch switch that is included with the TIG torch. This is used to control the torch cycle through preset functions of Pre/Post Flow, Up/Down Slope, Start/End Amps. In 2T mode, the torch switch is simply pressed and held to cycle the torch. Once arc termination is desired, the switch is released. In 4T mode, the Torch trigger is held down to start the pre-flow and initiate the arc at the “Start Amp” setting. The switch is then released and the unit begins up-slope until it reaches the welding current. The weld is continued without the switch being pressed. Once the weld is nearing finish, the torch switch is once again pressed and held to down slope to the “End Amp” setting. Then the torch is released to terminate the arc and begin post flow. The addition of the Finger 2T and 4T is simply a type of amptrol torch which utilizes separate switches along with an amp control mounted on the torch. Rather than a slider which has the on/off switch built into the movement like a foot pedal would have, the switch is independent from the potentiometer. (In the Power-Set mode this is also referred to as “Remote” when selecting a start type which combines start type and control type together.)

**Crater.** The weld crater is the sunken area left at the end of the weld where the weld pool solidified. This divot is detrimental to welds and cause cracking or create a point of weld stress as the weld metal tends to shrink at this point. The crater should be filled before terminating the arc. In best practice, this is done during the down-slope stage of the weld cycle.

**Down-Slope.** During the weld cycle, the machine Amp output may be gradually decreased as the crater is filled. The amount of time set determines the crater fill time that you have available. The Down-Slope reduces the Amps slowly until it reaches the End Amp setting. Down-Slope time is not always necessary, particularly during basic 2T operations such as tacking. Set Down-Slope to 0.0 when not needed in 2T mode. It is manually signaled when the torch trigger is pressed and held for the second time in 4T mode. **NOTICE:** *Down-Slope time should not be used in Foot-Pedal mode. Set Down-slope time to 0.0.*

**End Amps.** The End Amp function is the final Amp setting of the weld cycle. This is the final current that is set before the arc is set to terminate. The End Amp setting can be used with the foot pedal or the torch switch. However, for best tail-off of the arc with the foot pedal, the End Amp setting should be set to the lowest value possible. If a large tungsten is used, however, a higher End Amp setting may be required to terminate the arc cleanly. Larger diameter Tungstens make starting and stopping an arc more difficult, so be sure to offset this issue with a higher End Amp setting, of at least 5 to 10 amps.

**Foot Pedal.** The foot pedal is used to start the arc and control the amperage throughout a preset range. This can also be accomplished with the use of the NOVA torch slider which can be ordered through Everlast. The slider switch acts the same as a foot pedal, but is mounted directly to the torch with a set of Velcro straps. This allows quick removal if needed.

**Post-Flow Time.** Post Flow time is the amount of time that the shielding gas flows after the weld is terminated. This helps to form a protective pocket of shielding gas around the still molten, or cooling weld to prevent harmful oxygen from the atmosphere from entering the weld and oxidizing it. Post-Flow time is also used to cool the torch head and consumables. Long weld times require more Post-Flow Time, but for small welds, 1 second of post-flow for every 20 amps set is usually sufficient.

## UNDERSTANDING DC TIG FUNCTIONS

### TERMS RELATED TO DC TIG FUNCTIONS

**Pre-Flow Time.** Pre-flow time is the amount of time that the shielding gas flows before the start of the weld. This is used to help provide clean arc starts and prevent oxidation of the weld metal by forming a pocket of shielding gas around the weld area before the arc starts. It also preserves the point on the Tungsten. Typical Pre-Flow times range from .5 to 1.5 seconds.

**Pulse.** The Pulse on this unit features both standard pulse and advanced AC pulse. Standard pulse can be used in both AC and DC modes. (Aluminum, Stainless, and Steel). Advanced AC pulse is for welding aluminum only and is only available in AC mode. Pulse is simply the cycling of the AC or DC current between a high amp value and a low amp value. Pulse frequency (Hz) controls the number of times this happens per second. Pulse Time-On controls how much relative time the pulse lingers in the high amp stage or the low amp stage of the pulse.

Standard Pulse is used to for several purposes:

1. To control heat. The pulse is used to help constrict the arc to prevent spreading of heat
2. To direct the arc. The confining action on the arc that the pulse improves directability of the arc when corner joints or tight places are being welded.
3. To improve appearance. The pulse can be slowed to provide, smooth, evenly spaced ripples in the weld, often referred to as the "stack of dimes" appearance. While it also helps to control heat in this mode, the effect is primarily for aesthetics.

See more information on pulse later in this manual.

**Start Amps.** The Start Amp function sets a beginning Amp setting that the arc starts with. This can be set low for thin materials, or high for thick aluminum which requires a heavy "punch" of Amps to develop a weld puddle. This can be used with either the foot pedal or the torch switch functions. For pedal use, however, set Start Amps at the minimum setting unless arc starting is difficult due to a large tungsten, or poorly prepped weld surface.



# SETTING UP WELDING PARAMETERS

## DC TIG FUNCTIONS AND PARAMETER SELECTIONS

### TIG STEEL/STAINLESS (DC TIG) SELECTION

To begin, select the TIG Steel/Stainless option by scrolling through the left menu array of LEDs. The LED will light and the following screen will display briefly. Pay attention to the shielding gas reminder, and make sure you have the shielding gas connected and turned on.

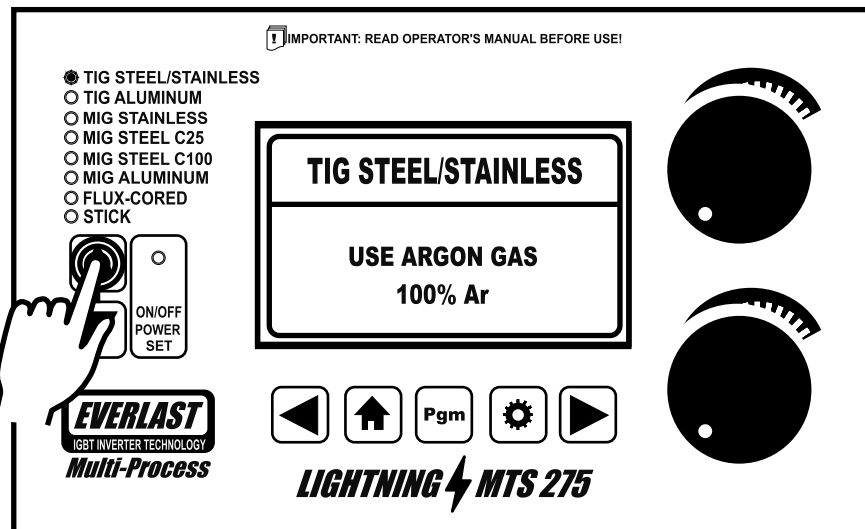

### SELECTION AND ADJUSTMENT OF TIG STEEL/STAINLESS (DC TIG) PARAMETERS

1. Once the process has been selected, use the right or left arrow button to select the desired parameter for adjustment. The selected parameter on the pin wheel will change color and be highlighted and ready for adjustment.
2. Rotate the top right knob to increase or decrease the parameter value.

**NOTICE:** One pinwheel segment OR square box will always be highlighted. The default highlighted position is the welding Amperage. This allows the top knob to control any highlighted parameter value. It is not necessary to return to the default welding Amperage position to weld, but it is a good idea to do so. This will allow on-the-fly adjustment of welding Amperage if needed.

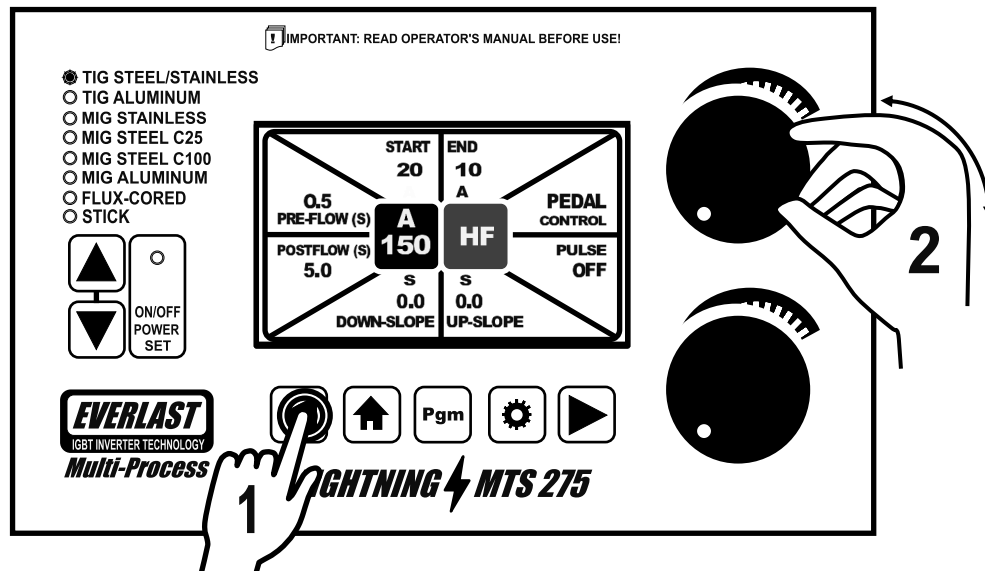

## SETTING UP WELDING PARAMETERS

### SELECTION AND ADJUSTMENT OF DC TIG (TIG STEEL/STAINLESS) IN POWER-SET MODE

**Important!** Before entering the Power-Set mode, be sure to select and adjust all basic settings such as pre-flow, control method etc. (except Amps). The Power-Set mode does not set these functions for you. **If at any time an adjustment needs to be made to the basic functions such as pre-flow, control type, start Amps etc., simply drop out of the Power-Set mode to make adjustments and then re-engage the Power-Set mode to continue the set-up process.**

The Power-Set mode offers a guided setup of Amps, by requiring the user to input Tungsten diameter and also the thickness of the Aluminum to determine a target setting for the Amperage. The Power-Set mode also takes into account the input voltage input to determine parameter input and output limits of some functions.

To enter the Power-Set mode and display the special Power-Set X menu:

- Make any necessary adjustment to the basic functions such as Pre/Post-Flow, Up/Down Slope, Start/End Amps, Control, Pulse etc.
- Enter Power-Set mode by pressing and releasing the Power-Set button. The LED above the Power-Set button should light up.
- Use the left arrow key to adjust the Tungsten diameter.
- Use the right arrow key to adjust the thickness of the weld metal that is being welded.
- Use the upper right knob to control Amperage.
- Use the lower right control knob to control Start Type.

**Hint:** If you do not know the metal thickness in inches or in standard gauges, there are apps that can be used to convert.

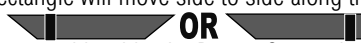
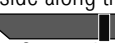
Once Tungsten diameter and metal thickness have been chosen, the unit will display a target welding Amperage in the upper, center display. The target Amperage is represented by a ✦ (4-pointed star) surrounded by a highlighted block located on a long bar in the upper section of the X menu:  The programed Amperage is based off of a standard flat welding position. Altering welding position may affect the accuracy of this setting. It may necessitate slight readjustment of the Amperage to fine tune the target setting. Other conditions can affect the accuracy such as individual welding preferences, tungsten type, etc. When deviating from the target Amp setting, the 4-pointed star will disappear. The rectangle will move side to side along the bar to represent the deviation from the target as you increase or decrease the value:  **OR**  However, to prevent setting the Amps too high to preserve the Tungsten, or too low to prevent cold welds, the Power-Set mode is limited in adjustment. Think of these limits in adjustment as a type of guard that keeps the user from selecting settings from going too far astray. If you find that you need more adjustment for whatever reason, you may drop out of the X menu and resume full manual adjustment.

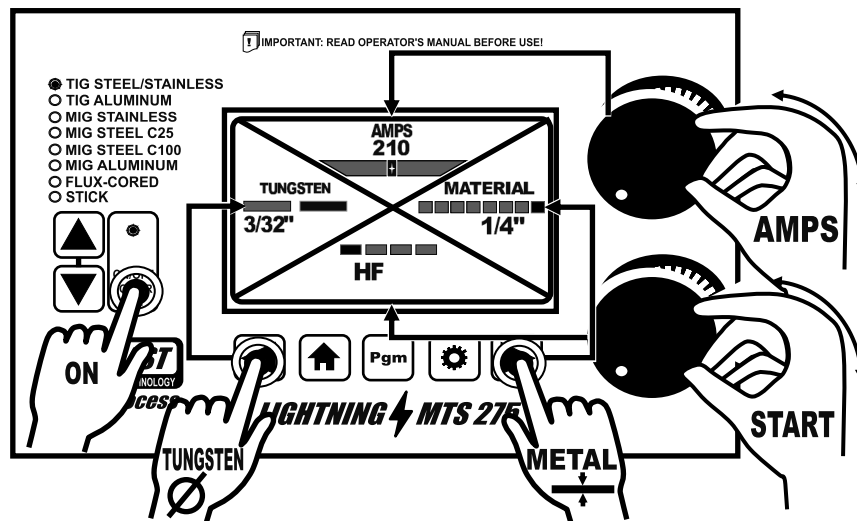

#### NOTICE:

120V operation limits the range of the input for material thickness due to the decreased output of the machine. If it appears that some X menu input selections for material thickness are limited, double check to see if the unit is plugged into 120V.

# SETTING UP WELDING PARAMETERS

## DC TIG FUNCTIONS AND PARAMETER SELECTIONS

### TIG STEEL/STAINLESS (DC TIG) SELECTION OF ARC STARTING

1. To select the arc start type, press and release the right arrow button one time to highlight the right square box that indicates arc start type. (This assumes the unit is in the default highlighted position: Amps)
2. Press and release the settings button to bring up the 4 way secondary menu to access the start types.
3. Press one of the arrow buttons to highlight the desired start type.
4. Once the start type has been highlighted, press and release the home button to return to the main pinwheel menu.

**NOTICE:** If there are any unassigned blocks in the 4-way menu, these will be skipped over during selection.

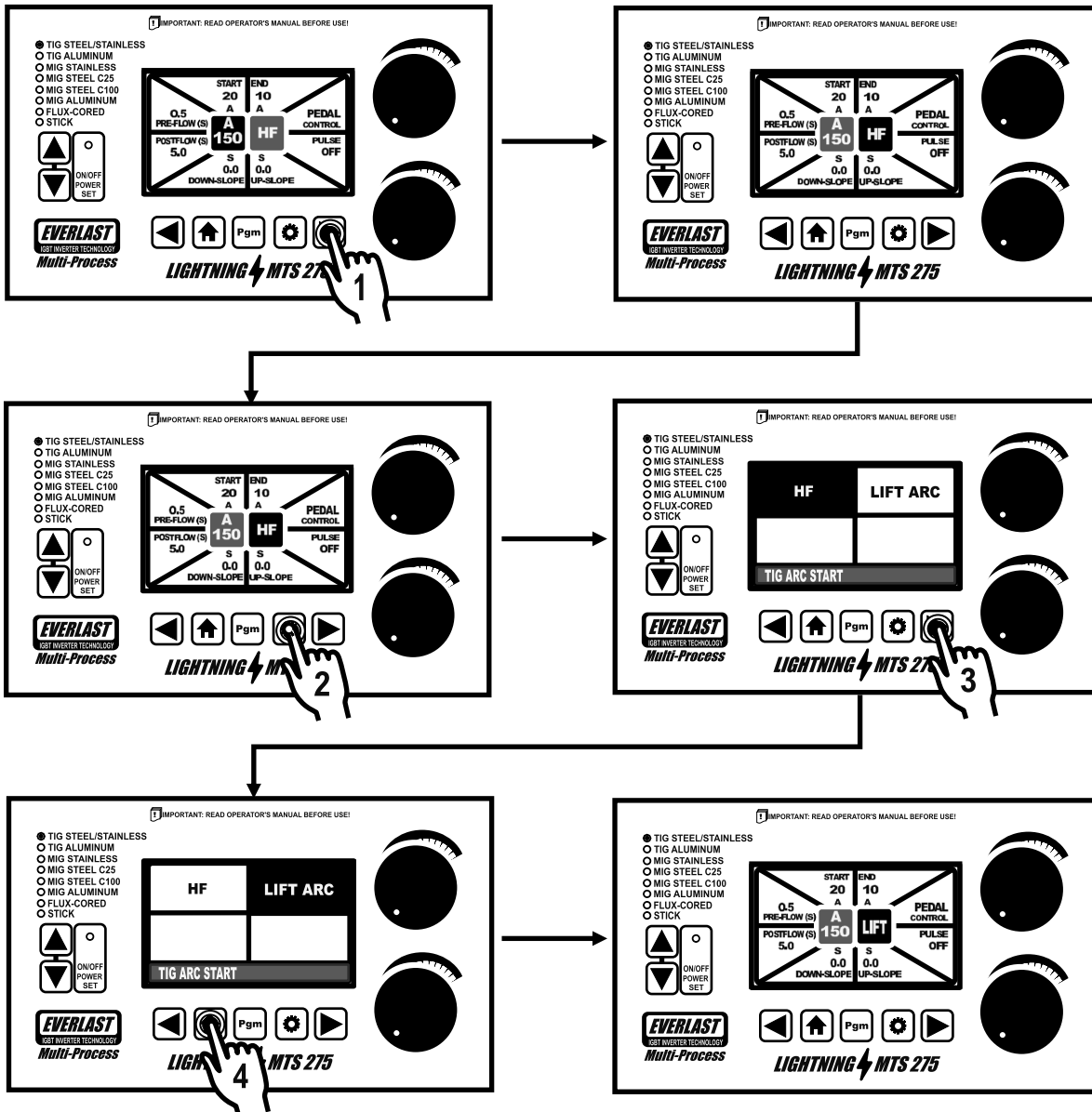

# SETTING UP WELDING PARAMETERS

## DC TIG FUNCTIONS AND PARAMETER SELECTIONS

### TIG STEEL/STAINLESS (DC TIG) SELECTION OF 2T/4T/PEDAL/FINGER OPERATION

1. To select the type of control function, press and release either one of the arrow buttons several times until the Control segment of the pinwheel is highlighted.
2. Press and release the settings button to bring up the 4 way secondary menu to access the control selections.
3. Press and release one of the arrow buttons to highlight the desired type of control.
4. Once the start type has been highlighted, press and release the home button to return to the main pinwheel menu. When the home setting is pressed, the highlighted segment in the pinwheel will remain in the control segment. To adjust the Amperage on-the-fly, use the arrow buttons to toggle back and highlight the default main (square) Amp segment when all adjustments are completed.

**NOTICE:** If the pedal control setting is used, up or down slope times are not used. Slope times are used for 2T and 4T control settings. The unit should ignore the slope time input. If slope times were adjustable, this would create a sluggish feel of the pedal and delay arc termination. If the control function is set to pedal, up/down slope times are set to 0.0 S.

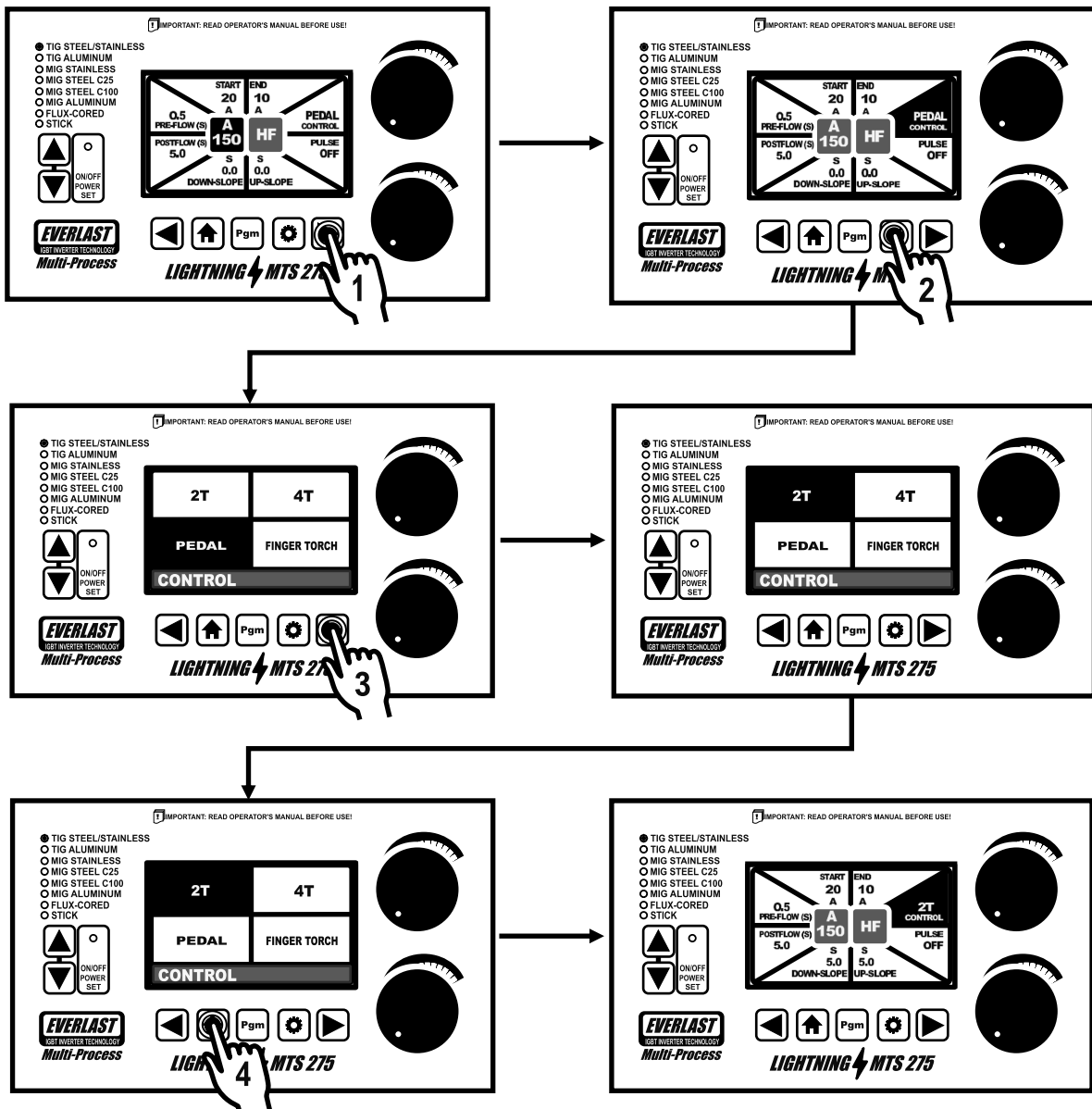

# SETTING UP WELDING PARAMETERS

## DC TIG FUNCTIONS AND PARAMETER SELECTIONS

### TIG STEEL/STAINLESS (DC TIG) SELECTION AND ADJUSTMENT OF PULSE

1. To turn on and adjust the parameters of the pulse function, press and release either one of the arrow buttons several times until the pulse segment of the pinwheel is highlighted.
2. Press and release the settings button to bring up the 4 way secondary menu to access the pulse on/off and pulse parameters.
3. Press and release one of the arrow buttons to highlight the **pulse-on** setting on the bottom bar. Once the Pulse is on, continue to press the arrow button to highlight the desired pulse parameter.
4. Rotate the top right control knob to adjust pulse parameters.
5. Once the pulse has been turned on and parameters have been adjusted, press and release the home button to return to the main pinwheel menu.

**NOTICE:** After selecting the pulse for adjustment, the arrow key toggles to the **pulse-on** first, then the selection jumps to the actual pulse parameters. If the pulse is already on, and needs to be turned off, press the arrow button until the **pulse-off** is highlighted. Once the pulse is turned off, simply press the home button to exit the 4-way menu.

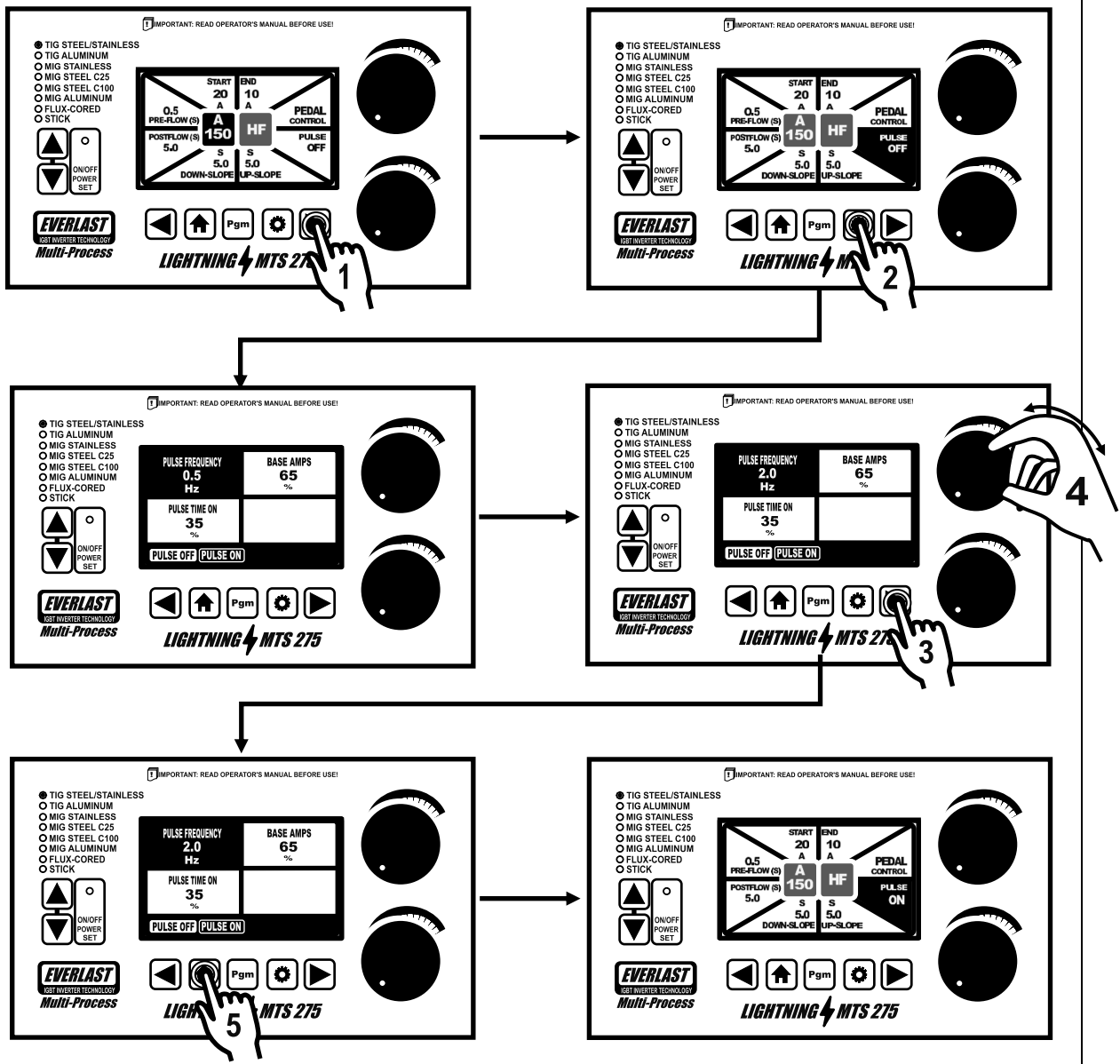

**⚠ CAUTION!**

When changing over from DC TIG (Stainless, Steel and other metals except Aluminum and Magnesium), to AC TIG (Aluminum and Magnesium), you must remember to change the location of the work clamp over to the red terminal marked "AC". If you do not, damage and incorrect operation may occur.

# TIG ALUMINUM (AC TIG)

## UNDERSTANDING AC TIG FUNCTIONS

### TERMS RELATED TO AC TIG FUNCTIONS

**AC Balance.** This refers to the amount of time that the AC wave form stays at either positive or negative polarity. In simple terms the amount of time that the unit spends in either positive or negative polarity can be skewed one way or the other to favor more Electrode positive, or more Electrode negative as the AC wave form cycles. This is the “balance” of the wave form. When applied to welding, the AC wave form can be divided into penetration and cleaning (the cathodic etching which removes oxides from the weld). Electrode positive is responsible for the “cleaning” portion of the cycle and Electrode negative is responsible for the penetration portion of the AC cycle. With the Lightning MTS, the unit displays cleaning as a percent (%) of electrode positive. As discussed, this represents the amount of cleaning achieved. For best all around results, set AC balance to 25 to 35% to begin.

**AC Frequency.** This refers to the number of times per second that the AC wave form cycles one full time between Electrode negative and Electrode Positive polarity. One cycle is one Hertz. On this unit AC frequency ranges from 20Hz to 200Hz.

**AC Wave Form.** This unit features the ability to select 4 distinct AC wave forms, which include Advanced Square-wave, Soft Square-wave, Triangular Wave, and Sine wave. AC wave form controls many different aspects of the welding process while welding Aluminum. Typical old-style transformers feature only a sine wave form, which is the same type of wave form created by power-companies and is the wave form that powers all AC devices, including welders in the US. However, with inverter technology, the wave form can be manipulated into different AC wave shapes. When applied to welding, these wave forms affect and control the intensity of the arc, wet-in of the puddle, and even the sound of the arc. Typically the Advanced Square wave offers the most heat input and the fastest wet-in of the puddle. The Soft Square wave, offers a smoother feel, but is less aggressive than the Advanced square wave. This is closer to the style of more modern square wave transformer welders. It's a good all around wave form, but isn't the most efficient or powerful. The triangular is the best wave form to use for thin gauge Aluminum. The triangular wave shape only spends a brief period at the peaks of the wave, which meets the Amperage set, but only for a fraction of the time a Square wave does, which spends the maximum amount of time at the peak of the wave form. This offers a cooler, less aggressive arc perfect for welding thin materials. The Sine Wave form, as mentioned offers a older transformer type feel. In terms of heat input in the weld, it falls between Soft Square Wave and Triangular Wave forms. The sine wave welds much slower at the same amp output than the Advanced Square wave, allowing more heat to build in the surrounding metal.

**Arc Start Type.** There are two basic forms of Arc starting that may be selected in manual mode, The user may select from either High Frequency (touchless) arc starting or Lift Start (Lift Arc) . High Frequency start sends an HF impulse to the torch tip to jump the gap between the Tungsten and the workpiece which establishes a circuit path for the welding arc to follow and ignite. Lift Start which uses the torch switch or foot pedal to send a low current to the Tungsten tip. Once the tip of the Tungsten is touched quickly to the work and raised up in a seamless motion, the welder senses the contact and sends full current through to the tip as it breaks contact with the work, igniting the arc. (See instructions on TIG arc starting later in this manual.)

**Amps. (A)** Amps are the measurement of the “pressure” of the electricity. Depending upon wave form, the display may read lower while welding than what is set, because the hall effect sensor measures and reports the average Amperage of a wave form, and not the peaks. This includes Pulse Amperage as it reports an average Amp value. Changing the Wave-form or Changing the Pulse settings affects the average Amperage. **NOTICE:** *When the foot pedal mode is activated, the unit will display selected maximum Amperage for a few seconds before defaulting to display the minimum welding Amperage. This is because the Amperage signal at the foot pedal is at the minimum position. When the foot pedal is pressed, or the torch slider is increased, the display will continue to reflect the Amperage dictated by the position of the pedal/slider. To recall the selected maximum Amperage, tap briefly on the pedal, or slightly rotate the top right control knob. In 2T or 4T mode, the selected amperage will continue to display until the arc is struck. After that the Amp display displays actual amp output, which may vary slightly from the preset Amperage.*

**Control.** The Control setting governs the function of the torch switch and foot pedal. The control offers several modes which include 2T, 4T, Pedal, 2T Finger and 4T Finger. The Pedal mode allows the unit to be controlled by the foot pedal or a torch slider or similar amptrol. 2T mode and 4T mode offer two modes used with the torch switch that is included with the TIG torch. This is used to control the torch cycle through preset functions of Pre/Post Flow, Up/Down Slope, Start/End Amps. In 2T mode, the torch switch is simply pressed and held to cycle the torch. Once arc termination is desired, the switch is released. In 4T mode, the Torch trigger is held down to start the pre-flow and initiate the arc at the “Start Amp” setting. The switch is then released and the unit begins up-slope until it reaches the welding current. The weld is continued without the switch being pressed. Once the weld is nearing finish, the torch switch is once again pressed and held to down slope to the “End Amp” setting. Then the torch is released to terminate the arc and begin post flow. The addition of the Finger 2T and 4T is simply a type of amptrol torch which utilizes separate switches along with an amp control mounted on the torch. Rather than a slider which has the on/off switch built into the movement like a foot pedal would have, the switch is independent from the potentiometer. (In the Power-Set mode this is also referred to as “Remote” when selecting a start type which combines start type and control type together.)

## UNDERSTANDING AC TIG FUNCTIONS

### TERMS RELATED TO AC TIG FUNCTIONS

**Crater.** The weld crater is the sunken area left at the end of the weld where the weld pool solidified. This divot is detrimental to welds and cause cracking or create a point of weld stress as the weld metal tends to shrink at this point. The crater should be filled before terminating the arc. In best practice, this is done during the down-slope stage of the weld cycle.

**Down-Slope.** During the weld cycle, the machine Amp output may be gradually decreased as the crater is filled. The amount of time set determines the crater fill time that you have available. The Down-Slope reduces the Amps slowly until it reaches the End Amp setting. Down-Slope time is not always necessary, particularly during basic 2T operations such as tacking. Set Down-Slope to 0.0 when not needed in 2T mode. It is manually signaled when the torch trigger is pressed and held for the second time in 4T mode. **NOTICE:** *Down-Slope time should not be used in Foot-Pedal mode. Set Down-slope time to 0.0.*

**End Amps.** The End Amp function is the final Amp setting of the weld cycle. This is the final current that is set before the arc is set to terminate. The End Amp setting can be used with the foot pedal or the torch switch. However, for best tail-off of the arc with the foot pedal, the End Amp setting should be set to the lowest value possible. If a large tungsten is used, however, a higher End Amp setting may be required to terminate the arc cleanly. Larger diameter Tungstens make starting and stopping an arc more difficult, so be sure to offset this issue with a higher End Amp setting, of at least 5 to 10 amps.

**Foot Pedal.** The foot pedal is used to start the arc and control the amperage throughout a preset range. This can also be accomplished with the use of the NOVA torch slider which can be ordered through Everlast. The slider switch acts the same as a foot pedal, but is mounted directly to the torch with a set of Velcro straps. This allows quick removal if needed.

**Post-Flow Time.** Post Flow time is the amount of time that the shielding gas flows after the weld is terminated. This helps to form a protective pocket of shielding gas around the still molten, or cooling weld to prevent harmful oxygen from the atmosphere from entering the weld and oxidizing it. Post-Flow time is also used to cool the torch head and consumables. Long weld times require more Post-Flow Time, but for small welds, 1 second of post-flow for every 20 amps set is usually sufficient.

**Pre-Flow Time.** Pre-flow time is the amount of time that the shielding gas flows before the start of the weld. This is used to help provide clean arc starts and prevent oxidation of the weld metal by forming a pocket of shielding gas around the weld area before the arc starts. It also preserves the point on the Tungsten. Typical Pre-Flow times range from .5 to 1.5 seconds.

**Pulse.** The Pulse on this unit features both standard pulse and advanced AC pulse. Standard pulse can be used in both AC and DC modes. (Aluminum, Stainless, and Steel). Advanced AC pulse is for welding aluminum only and is only available in AC mode. Pulse is simply the cycling of the AC or DC current between a high amp value and a low amp value. Pulse frequency (Hz) controls the number of times this happens per second. Pulse Time-On controls how much relative time the pulse lingers in the high amp stage or the low amp stage of the pulse. The advanced pulse is actually a mix of AC and DC-. This can be used for improving penetration on thick metals, or for improving bead profile on thin metals.

Standard Pulse is used to for several purposes:

1. To control heat. The pulse is used to help constrict the arc to prevent spreading of heat
2. To direct the arc. The confining action on the arc that the pulse improves directability of the arc when corner joints or tight places are being welded.
3. To improve appearance. The pulse can be slowed to provide, smooth, evenly spaced ripples in the weld, often referred to as the "stack of dimes" appearance. While it also helps to control heat in this mode, the effect is primarily for aesthetics.

See more information on pulse later in this manual.

**Start Amps.** The Start Amp function sets a beginning Amp setting that the arc starts with. This can be set low for thin materials, or high for thick aluminum which requires a heavy "punch" of Amps to develop a weld puddle. This can be used with either the foot pedal or the torch switch functions. For pedal use, however, set Start Amps at the minimum setting unless arc starting is difficult due to a large tungsten, or poorly prepped weld surface.



## SETTING UP WELDING PARAMETERS

### AC TIG FUNCTIONS AND PARAMETER SELECTIONS

#### TIG ALUMINUM SELECTION

To begin, select the TIG Aluminum option by scrolling through the left menu array of LEDs. The LED will light and the following screen will display briefly. Pay attention to the shielding gas reminder, and make sure you have the shielding gas connected and turned on.

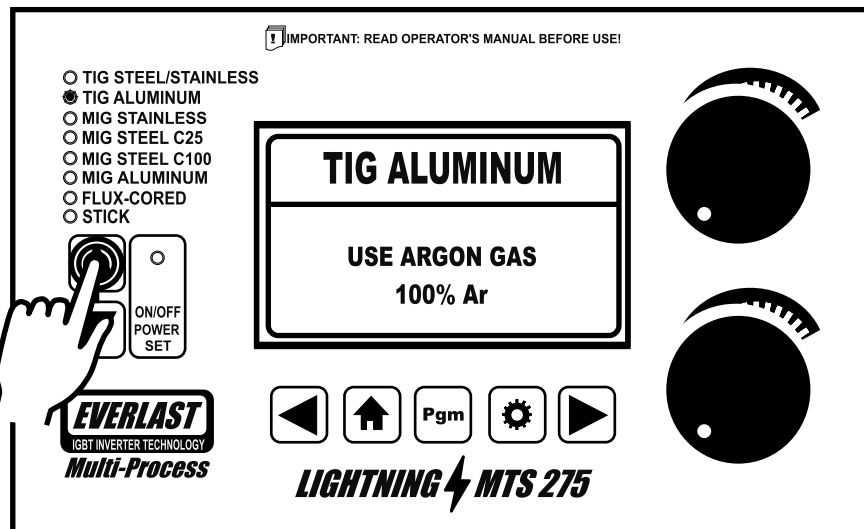

#### SELECTION AND ADJUSTMENT OF TIG ALUMINUM PARAMETERS

1. Once the process has been selected, use the right or left arrow button to select the desired parameter for adjustment. The selected parameter on the pin wheel will change color and be highlighted and ready for adjustment.
2. Rotate the top right knob to increase or decrease the parameter value.

**NOTICE:** One pinwheel segment OR square box will always be highlighted. The default highlighted position is the welding Amperage. This allows the top knob to control any highlighted parameter value. It is not necessary to return to the default welding Amperage position to weld, but it is a good idea to do so. This will allow on-the-fly adjustment of welding Amperage if needed.

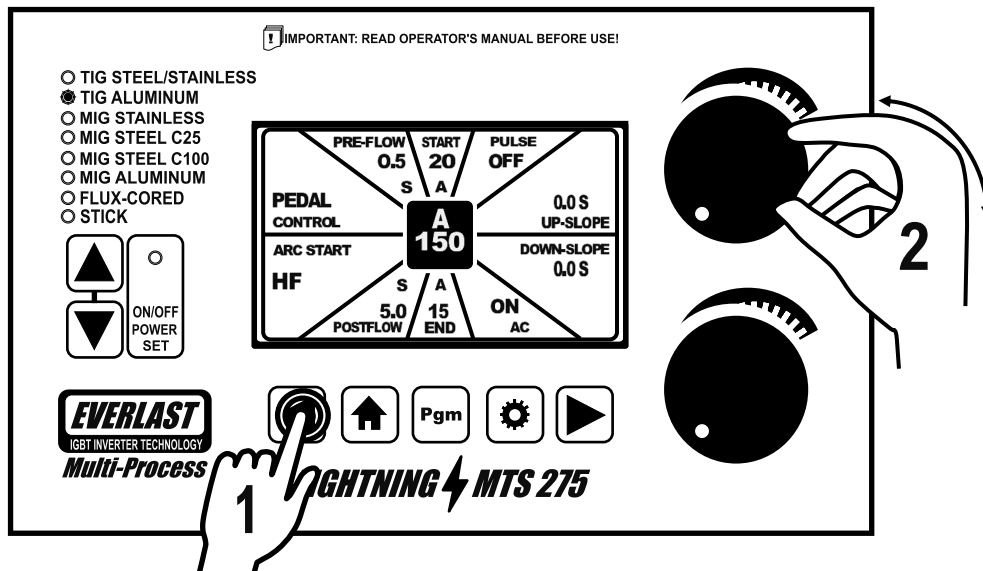

## SETTING UP WELDING PARAMETERS

### SELECTION AND ADJUSTMENT OF AC TIG (TIG ALUMINUM) IN POWER-SET MODE



**Important!** Before entering the Power-Set mode, be sure to select and adjust all basic settings such as pre-flow, control method etc. (except Amps). The Power-Set mode does not set these functions for you. **If at any time an adjustment needs to be made to the basic functions such as AC wave form, pre-flow, control type, start Amps etc., simply drop out of the Power-Set mode to make adjustments and then re-engage the Power-Set mode to continue the set-up process.**

The Power-Set mode offers a guided setup of Amps, by requiring the user to input Tungsten diameter and also the thickness of the Aluminum to determine a target setting for the Amperage. The Power-Set mode also takes into account the input voltage input to determine parameter input and output limits of some functions.

To enter the Power-Set mode and display the special Power-Set X menu:

- Make any necessary adjustment to the basic functions such as Pre/Post-Flow, Up/Down Slope, Start/End Amps, Control, Wave Form etc..
- Enter Power-Set mode by pressing and releasing the Power-Set button. The LED above the Power-Set button should light up.
- Use the left arrow key to adjust the Tungsten diameter.
- Use the right arrow key to adjust the thickness of the Aluminum metal that is being welded.
- Use the upper right knob to control Amperage.
- Use the lower right control knob to control Start Type.

**Hint:** If you do not know the metal thickness in inches or in standard gauges, there are apps that can be used to convert.

Once Tungsten diameter and metal thickness have been chosen, the unit will display a target welding Amperage in the upper, center display. The target Amperage is represented by a ✦ (4-pointed star) surrounded by a highlighted block located on a long bar in the upper section of the X menu:  The programmed Amperage is based off of a standard flat welding position. Altering welding position may affect the accuracy of this setting. It may necessitate slight readjustment of the Amperage to fine tune the target setting. Other conditions can affect the accuracy such as individual welding preferences, additions of Helium, etc. When deviating from the target Amp setting, the ✦ -pointed star will disappear. The rectangle will move side to side along the bar to represent the deviation from the target as you increase or decrease the value:  **OR** 

However, to prevent setting the Amps too high to preserve the Tungsten, or too low to prevent cold welds, the Power-Set mode is limited in adjustment. Think of these limits in adjustment as a type of guard that keeps the user from selecting settings from going too far astray. If you find that you need more adjustment for whatever reason, you may drop out of the X menu and resume full manual adjustment. In AC mode, when welding at the upper range of the Tungsten's Amp bearing threshold, performance may not be ideal even with the properly inputted settings. The tungsten may ball or blister. The arc may become erratic. To combat this, drop out of the Power-Set mode and lower AC balance, AC frequency, or select another wave form.

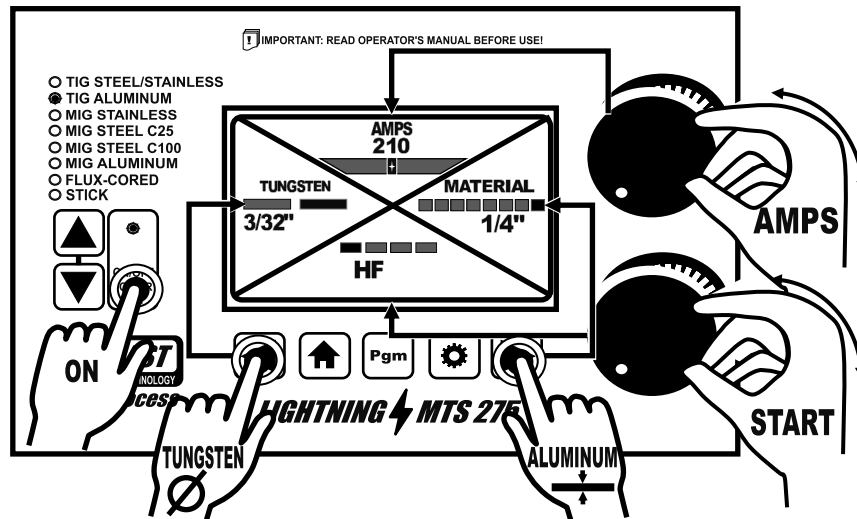

#### NOTICE:

120V operation limits the range of the input for material thickness due to the decreased output of the machine. If it appears that some X menu input selections for material thickness are limited, double check to see if the unit is plugged into 120V.

## SETTING UP WELDING PARAMETERS

### AC TIG FUNCTIONS AND PARAMETER SELECTIONS

#### TIG ALUMINUM (AC TIG) SELECTION OF ARC STARTING

1. To select the arc start type, press and release the right or left arrow button until the arc start pinwheel segment is highlighted.
2. Press and release the settings button to bring up the 4 way secondary menu to access the start types.
3. Press one of the arrow buttons to highlight the desired start type.
4. Once the start type has been highlighted, press and release the home button to return to the main pinwheel menu.

**NOTICE:** If there are any unassigned blocks in the 4-way menu, these will be skipped over during selection.

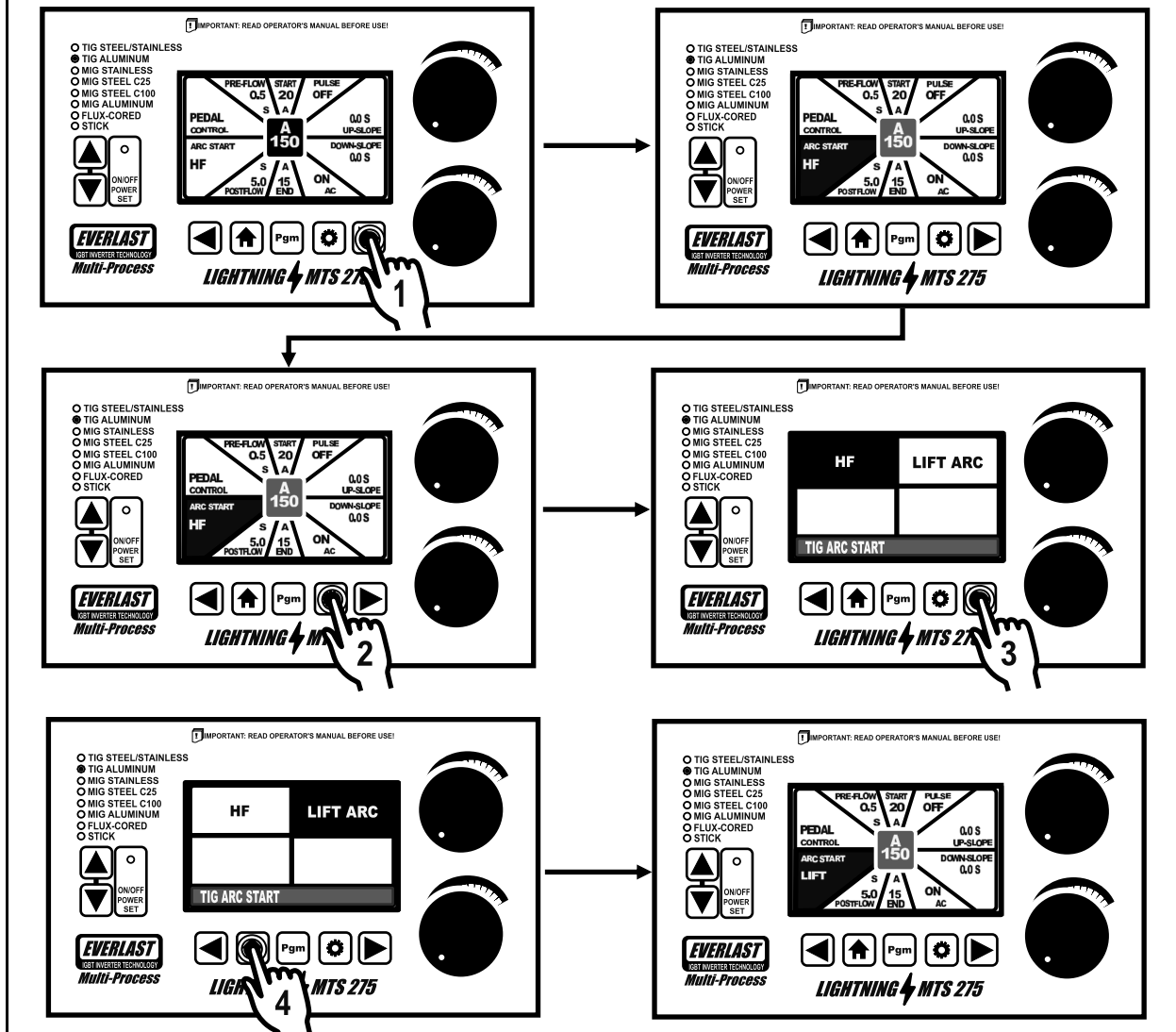

#### HELPFUL HINT:

AC welding is typically performed only with HF (High Frequency) starting. Lift start/arc starting in AC can contaminate the tungsten when welding AC. However, sometimes it may be necessary to use lift start in AC mode due to restrictions caused by the location. Places like hospitals, computer rooms etc. are sensitive to HF and may ban or restrict the use of any HF device. If so, then use the lift start mode. But use a scrap piece of clean copper to strike the arc on, and then transfer the arc over to the piece being welded. This will help prevent weld contamination and prolong tungsten life.

# SETTING UP WELDING PARAMETERS

## AC TIG FUNCTIONS AND PARAMETER SELECTIONS

### TIG ALUMINUM (AC TIG) SELECTION OF 2T/4T/PEDAL/FINGER OPERATION

1. To select the type of control function, press and release one of the arrow buttons until the control segment of the pinwheel is highlighted.
2. Press and release the settings button to bring up the 4 way secondary menu to access the control selections.
3. Press and release one of the arrow buttons to highlight the desired type of control.
4. Once the start type has been highlighted, press and release the home button to return to the main pinwheel menu.

**NOTICE:** When the home setting is pressed, the highlighted segment in the pinwheel will remain in the control segment. To adjust the Amperage on-the-fly, use the arrow buttons to toggle and highlight the square block representing the Amps.

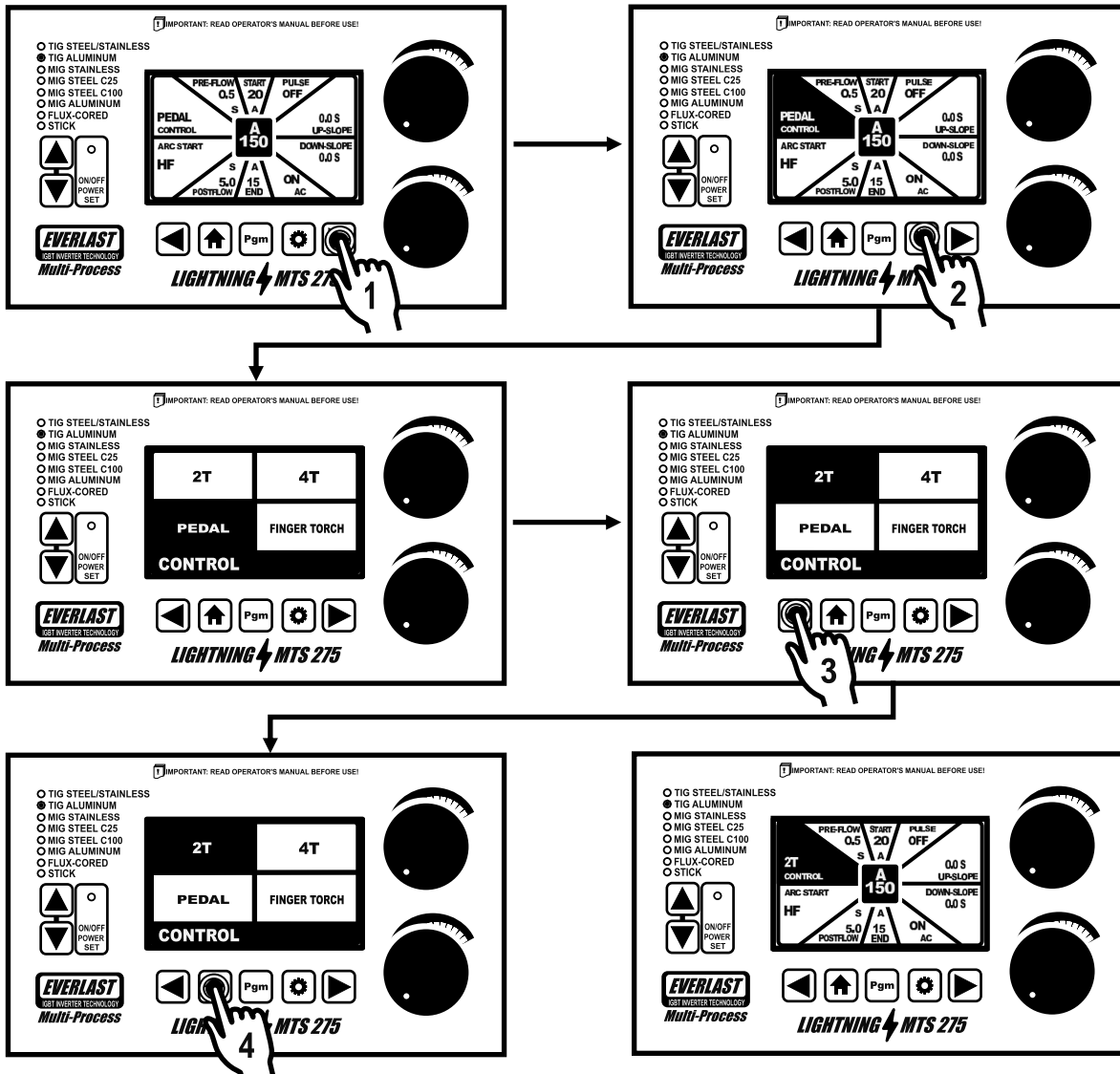

#### HELPFUL HINT:

If the pedal control setting is on, up or down slope times are not needed. Up and down slope time are used for 2T and 4T control settings. Depending upon the program version of your unit, the unit may ignore the slope time input, even if slope is able to be set. Some program versions may allow setting of slope values and will use these settings in pedal mode. If so, this will make using the pedal feel sluggish and delay arc stopping. If operating in the Pedal mode, always set up and down slope value to 0.0.

# SETTING UP WELDING PARAMETERS

## AC TIG FUNCTIONS AND PARAMETER SELECTIONS

### TIG ALUMINUM (AC TIG) SELECTION AND ADJUSTMENT OF PULSE AND ADVANCED PULSE

To turn on and adjust the parameters of the pulse OR advanced pulse (mixed TIG) function:

1. Press and release either one of the arrow buttons several times until the pulse segment of the pinwheel is highlighted.
2. Press and release the settings (gear icon) button to bring up the 4 way secondary menu to access the pulse on/off and pulse parameters.
3. Press and release one of the arrow buttons to highlight the **pulse-on or advanced (pulse)** setting on the bottom bar. Once the Pulse or Advanced Pulse is highlighted, continue to press the arrow button to highlight the desired pulse parameter.
4. Rotate the top right control knob to adjust pulse parameter values.
5. Once the pulse has been turned on and parameters have been adjusted, press and release the home button to return to the main pinwheel menu.

**NOTICE:** After selecting the pulse for adjustment, the arrow key toggles to the **pulse-on** first, then the selection jumps to the actual pulse parameters. If the pulse is already on, and needs to be turned off, press the arrow button until the **pulse-off** is highlighted. Once the pulse is turned off, simply press the home button to exit the 4-way menu.

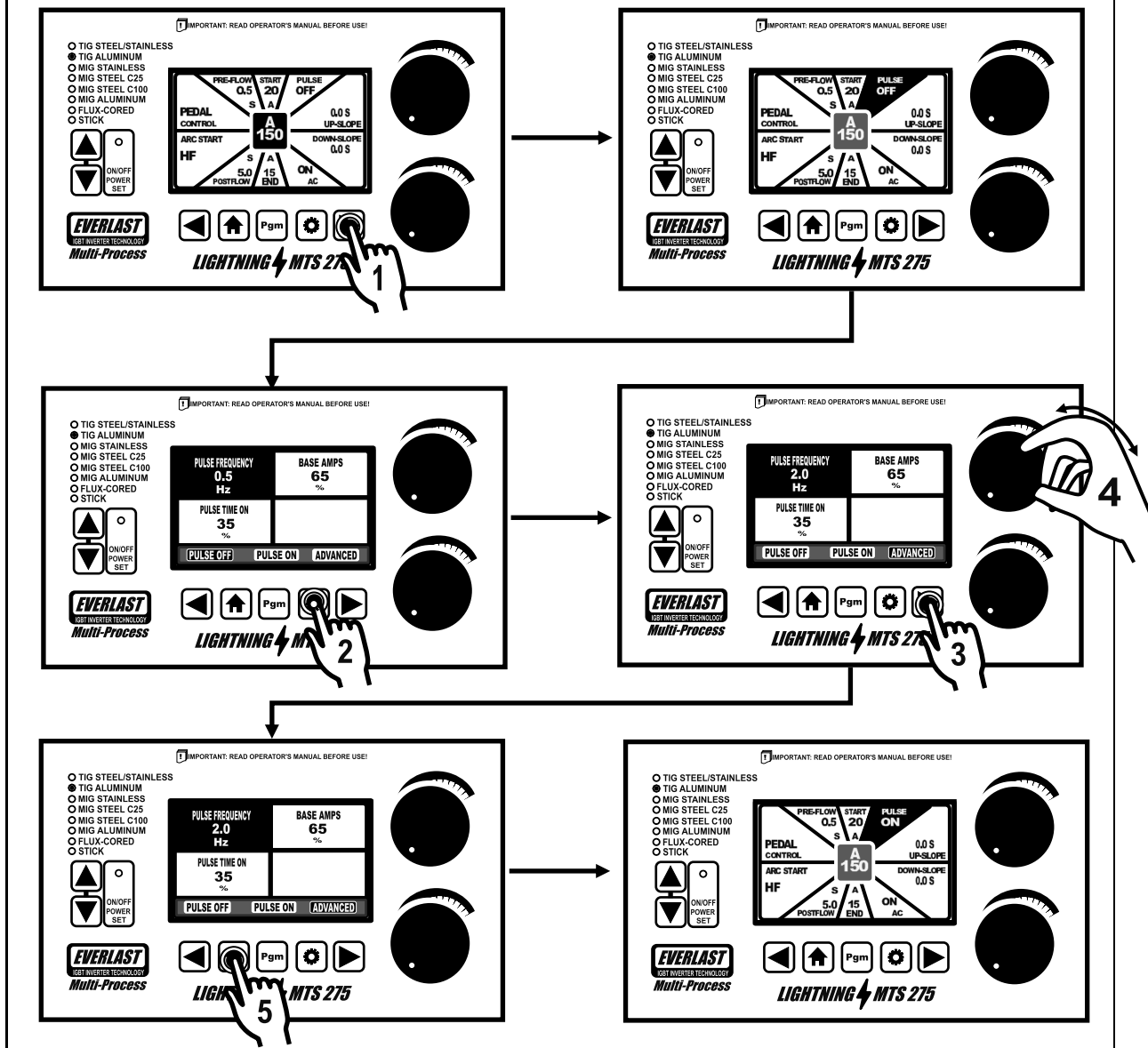

# SETTING UP WELDING PARAMETERS

## AC TIG FUNCTIONS AND PARAMETER SELECTIONS

### TIG ALUMINUM (AC TIG) WAVE FORM SELECTION AND ADJUSTMENT OF AC FREQUENCY AND BALANCE

To select the wave form and adjust the AC Frequency and Balance:

1. Press and release one of the arrow buttons until the AC segment of the Pinwheel is highlighted.
2. Press and release the settings (gear icon) button to access the 4-way menu. The AC wave form is selectable from this menu. The AC Frequency and AC Balance may also be adjusted from this menu.
3. Use one of the arrow buttons to highlight the desired wave form. Choose between Advanced Square Wave, Soft Square Wave, Sine Wave or Triangular wave shapes. (Indicated by the shape of the icon.)
4. Use the top knob to adjust AC Balance. Use the bottom knob to adjust AC Frequency.
5. Press and release the home button to return to the main pinwheel menu.

**NOTICE:** When in Aluminum AC TIG mode, the AC segment will always indicate "On". This is simply a reminder and a point of access for the AC Frequency, AC Balance and AC wave form. In Steel/Stainless DC TIG mode this segment is not present. The 4-Way menu departs from the typical function of the other 4-Way menus. In this instance, both top and bottom knobs are used. The arrow keys are used only for selecting the wave form and nothing else on this screen.

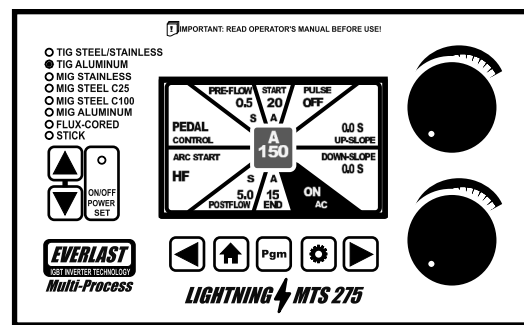
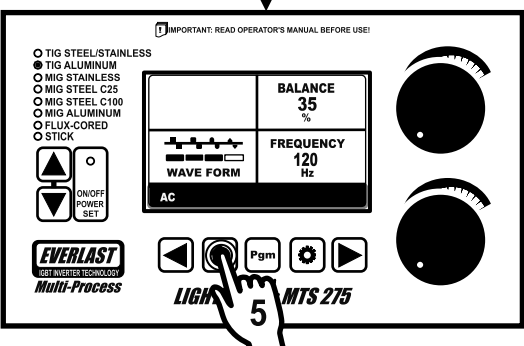
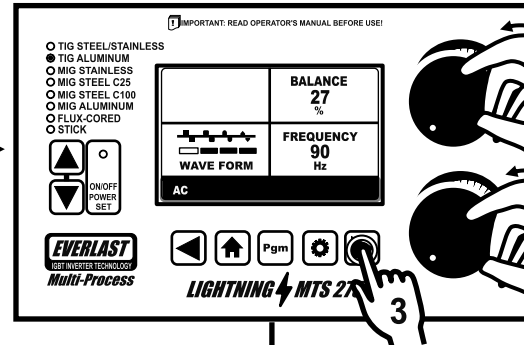
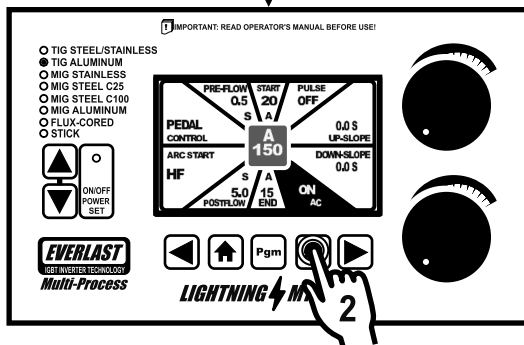
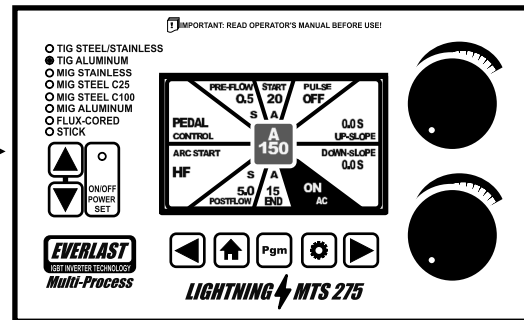
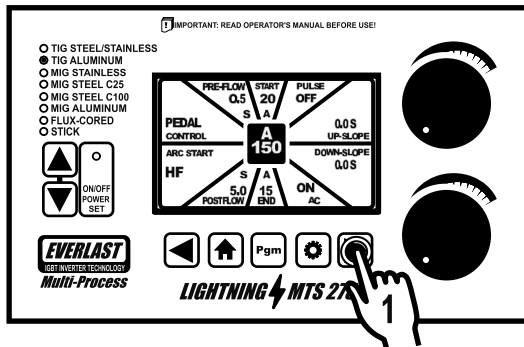

**NOTICE:**

The sections on MIG and Flux-Cored adjustment and operation have been combined since setup and adjustment is similar. Where there are exceptions, it will be noted.

# MIG/Flux-Cored

## UNDERSTANDING MIG FUNCTIONS

### TERMS RELATED TO MIG/FLUX-CORED SETUP

**Amps. (A)** Amps are directly related to wire feed speed in MIG and Flux-Cored operation. The type of wire, the diameter of the Wire and the Wire feed speed govern the amount of current that flows as wire is fed. This is comparable to the rate of “flow” of water. While Amps aren’t shown on the panel, WFS controls the Amp output of the unit.

**Burn-Back.** The Burn-Back setting is the amount of time that the welder keeps the wire energized *after* the drive stops feeding. This reduces the need for trimming the wire by melting the wire back to a length preset by the timer. Ordinarily, the wire Burn-Back Setting should be set for .1 or .2 seconds. Excessive burn back time will result in the wire burning back and even into the tip. To maximize the effectiveness of the Burn-Back function, momentarily hover over the weld after welding has stopped to maintain continuity and allow the Burn-Burn Back to do its job.

**Control.** The Control setting governs the function of the torch switch as well as selects Spool gun operation. In 2T mode, the torch switch is simply pressed and the unit begins to feed the wire according to the programming on the panel. In 4T mode, the torch switch is pressed to start the arc (begin the run in) and then released to slope up and weld. To stop welding in the 4T mode, the torch switch is pressed again, to down-slope and finally released to terminate the arc. The 2T/4T mode is selectable for spool gun use. Ordinarily, 2T operation is selected. NOTICE: The Use of the Spot/Stitch function allows use with 2T only.

**Crater.** The weld crater is the sunken area left at the end of the weld where the weld pool solidified. This divot is detrimental to welds and cause cracking or create a point of weld stress as the weld metal tends to shrink at this point. The crater should be filled before terminating the arc. In best practice, this is done during the down-slope stage of the weld cycle.

**Down-Slope.** During the weld cycle, the machine output may be gradually decreased as you begin to fill the crater. The amount of time set determines the crater fill time that you have available. The Down-Slope reduces the wire speed slowly until it reaches the End setting. Down-Slope is not always necessary, particularly during basic 2T operations such as tacking. Set Down-Slope to 0.0 when not needed in 2T mode. It is manually signaled when the torch trigger is pressed and held for the second time in 4T mode.

**End.** The End is the final stage of the weld cycle. This is measured in inches per minute, and is displayed as WFS (Wire Feed Speed). This is the final, or destination WFS used when the weld arc is terminated. This is determines how “low” the wire feed speed goes. If instant arc termination is desired set the End WFS to the same main WFS.

**Inductance.** Inductance controls the amount of fluidity of the weld puddle. A fluid puddle is associated with a softer, smoother arc. A flatter weld is the result. A colder puddle, with less wet-in, and lower fluidity often results in a taller, or even “piled-up” appearance to the weld. As Inductance increases, the raspiness of the sound increases, and spatter tends to disappear. With an extreme amount of inductance, though, spatter begins to reappear at the very end of the range. Too low of an Inductance leads to a high pitch whine, and spatter may tends to increase, with a high ridge developing in the center of the weld. However, low inductance levels are good for thin materials, reducing burn-through. Increasing Inductance increases the fluidity, and general heat of the puddle. Often referred to as Welder Slope or Welder Choke, the Inductance controls the current rise time after the arc has shorted out during the short-circuit weld process. As the current rises after a short circuit, the wire begins to burn back to a point where it pinches off and transfers to the puddle. This happens many times a second in reality, in rapid repetition. The Inductance can be tuned for improving arc performance out of position, and on thin materials. It can also be used to compensate for performance issues when using different shielding gases or metal types. The importance of Inductance cannot be overstressed. With older style machines, Inductance was fixed. In fact, many manufacturer’s even today choose to fix their inductance at a pre-set level. All machines have some inductance. However, the amount varies by manufacturer. This is what leads some owners to prefer one brand over another as people prefer (without knowing it) a different level of inductance over another. Adjustable inductance ensures that the unit welds equally well with steel as it does with stainless steel, or that it welds similarly with steel and a 75/25 Ar/CO2 mix as it does with a 100% CO2 mix.

Use the following suggested ranges for Inductance settings and fine tune thereafter for preference and application:

MIG C25: 65-75%

MIG 100: 30-50%

MIG Stainless: 80-95%

MIG Aluminum: 50– 70%

Flux-Cored:40-70%

**NOTICE:** Setting Inductance to 0 does not turn it off! This only serves to create worse arc performance and unsatisfactory weld behavior. For best results only fine tune Inductance after Volts and Wire Feed Speed have been dialed-in. Extremely high inductance levels may cause starting issues as well.



## UNDERSTANDING MIG FUNCTIONS

### TERMS RELATED TO MIG/FLUX-CORED SETUP

**Start.** This is the initial wire feed speed (WFS) that helps start the weld. Expressed in Inches per Minute, this can be used interchangeably with the term run-in, which is designed to slow the run-in of the welder so that the wire doesn't tend to stutter (machine-gun) when you start the weld. Or the wire speed can be set a bit higher if desired than the wire feed speed used when welding. In 2T this is automatically carried out. In 4T, this is the first stage of the weld cycle when the trigger is pulled for the first time. If no run-in is desired, set to the same setting as the main WFS. However, lowering run-in does improve start quality.

**Pre-Flow.** This is the amount of time (in seconds) that shielding gas flows at the first stage of the weld cycle before welding begins. Pre-Flow is used to improve starts and weld quality at the beginning of the weld. By using Pre-Flow to form a pocket of shielding gas to start the arc in, porosity at the beginning of the weld can be reduced. This is used in TIG welding frequently, but previously only offered in more expensive MIG welders where high quality welds are demanded. For basic welding where top quality welds aren't required, the Pre-Flow can be set to 0.0. However, for welds where good, porosity free-starts is a concern, set Pre-Flow for .5 to 1 second for most welds. More time can be used, of course, but this will begin to significantly delay the start of the weld because welding will not start until the Pre-Flow time is over.

**NOTICE:** If you try to weld and no wire is fed initially, check pre-flow times to make sure a long pre-flow hasn't been set.

**Post-Flow.** This is the amount of time (in seconds) that shielding gas flows after welding has been completed. This is used to help cool the weld and the MIG gun after welding is completed. The Post-Flow is also used to improve weld quality at the crater. If gas suddenly ceases at the end of the weld, while the weld is still molten, or still glowing, the weld can quickly oxidize. The Post-Flow provides a shielding pocket of the gas around this area and prevents oxygen from the atmosphere getting to the weld. If Post-Flow is not required, the Post-Flow can be set to 0.0. However, if burn back time is used, it does also help keep the wire from oxidizing while the burn back timer cycles and the wire cools. For the best quality welds, set Post-Flow timer to 1 to 3 seconds for most welding applications. More can be used, of course, but be careful not to waste too much gas. To make the most of the Post-Flow time, hover over the weld with the MIG gun until the Post-Flow stops.

**Spot/Stitch.** Spot and Stitch are separate functions, but are combined on the panel because their functions are linked. The Spot timer is used to make spot welds, which require precision and consistency in size. The Spot timer (in seconds) automatically controls the length of time the welder feeds and energizes the wire when the gun trigger is pulled and held. This is used most often in body work, and tacking operations. As the user pulls the trigger and holds it in, the Spot timer energizes the welder for the time the user selects and then automatically shuts off the weld output and feeding when the time expires as the trigger is still held down. To reset and spot another weld, release the trigger and press and hold it again, until the cycle times out. The Stitch timer is used in combination with Spot timer to provide an "off" period between individual spot welds, while the gun trigger is held continuously. By holding the gun trigger down, this will provide a regular on and off cycling of the welder or tack large sections of body panels with regularly spaced welds. The Spot timer can be used without a Stitch timer setting. If Spot only operation is desired, set Stitch to 0.0. Stitch cannot be used without a Spot timer setting.

**NOTICE:** If installing wire, or trying to feed wire with the trigger pulled and the wire feeds and then stops after a short amount of time, or it seems to pulse on and off, check to make sure Spot and Stitch timers are not on.

**Volts.** If electricity is compared to water (as it often is because of their similarities in behavior), Voltage would be the same as pressure. Voltage in MIG is considered constant and is used to control arc length, basic weld bead height/width and wire burn-off rate. The Voltage setting is sometimes referred to as "heat" in the welding field. Having too much Voltage results in undercutting, fast burn off rate of the wire, wire burning back into the tip while welding, and excessive spatter. Too little Voltage results in the wire piling up unmelted, or a high ridge in the center of the weld, incomplete fusion at the toes of the weld, and possibly large pieces of wire flying off while welding. Too little welding Voltage can result in poor arc starts and what feels like the wire stubbing in to the puddle and "pushing" off the weld intermittently.

**WFS (Wire Feed Speed).** The wire feed speed is registered in Inches Per Minute (IPM). This is the rate at which the wire is fed into the weld. When combined with the correct voltage, it helps to control penetration. (Penetration is the amount ingress that the molten pool makes into the base metal being welded, and to some extent the profile of the bottom of the molten puddle). Wire Feed speed is also controls Amperage. The faster wire feeds into the puddle, the greater the Amp output. The slower the wire feeds into the puddle, the lower the Amp output. Though WFS controls amperage, it does so indirectly. Amperage in most simple terms is a product of wire type (conductivity of the filler metal), wire diameter, and wire feed speed. If any varies, Amperage will vary. For example, .023" and .045" steel wire will deliver a different amperage per inch of wire fed. It takes about 3.5 inches of .023" of steel wire to deliver 1 amp. For .045", it only takes one inch of wire to deliver the same amp to the weld. So, in steel, to achieve the same equivalent amperage with .023" wire, you'd need approximately 3.5 times the wire speed of .045" wire.

# SETTING UP WELDING PARAMETERS

## MIG/Flux-Cored Functions and Parameter Selections

### MIG/FLUX-CORED FUNCTION SELECTION

To begin, select the desired MIG or Flux-Cored option by scrolling through the left menu array of LEDs. The LED will light and the following screens will display briefly. Pay attention to the shielding gas reminder, and make sure you have the shielding gas connected and turned on for MIG. Flux-Cored requires no gas. For Dual-shield select a MIG setting that corresponds to the shielding gas used.

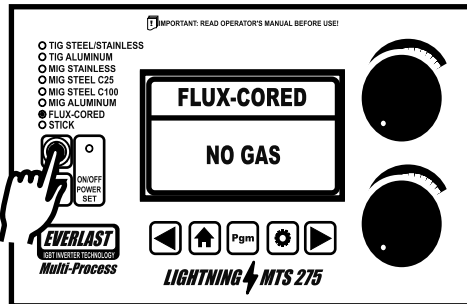
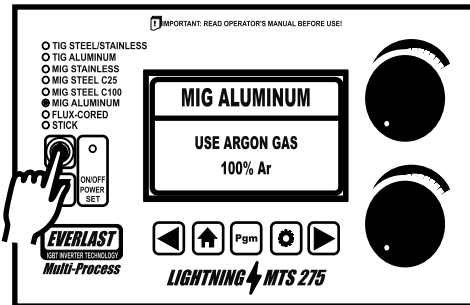
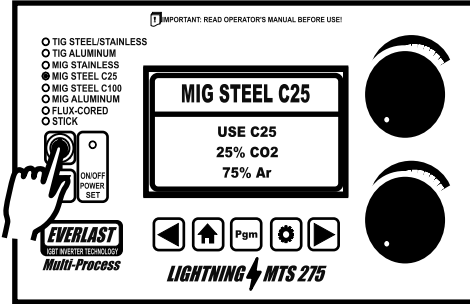
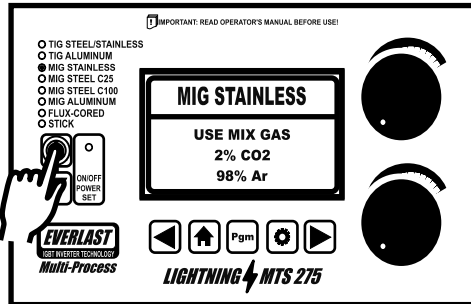

# SETTING UP WELDING PARAMETERS

## SELECTION AND ADJUSTMENT OF MIG/FLUX-CORED PARAMETERS

1. Once the process has been selected, use the right or left arrow button to select the desired parameter for adjustment. The selected parameter on the pin wheel will be highlighted in red, indicating this parameter is ready for adjustment.
2. Rotate the top right knob to increase or decrease the parameter value.
3. For items such as Control and Spot/Stitch, the user will need to press and release the settings (gear icon) to access the secondary 4-way menu to adjust the parameters or change method of operation. Press the home (house icon) button to return to the main pinwheel menu.

**NOTICE:** One pinwheel segment OR WFS box will always be highlighted. The default highlighted position is the Wire Speed Feed (registers in Inches Per Minute/IPM). This allows the top knob to control any highlighted parameter value. It is not necessary to return to the Wire Feed Speed position to weld, but it is a good idea to do so. This will allow on-the-fly adjustment of Wire Feed Speed.

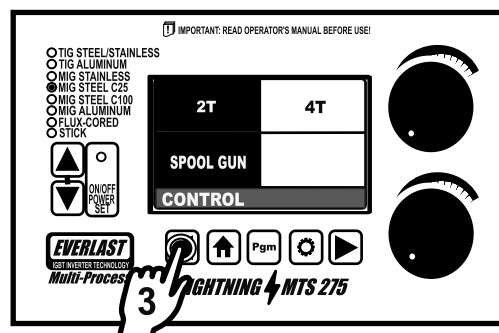
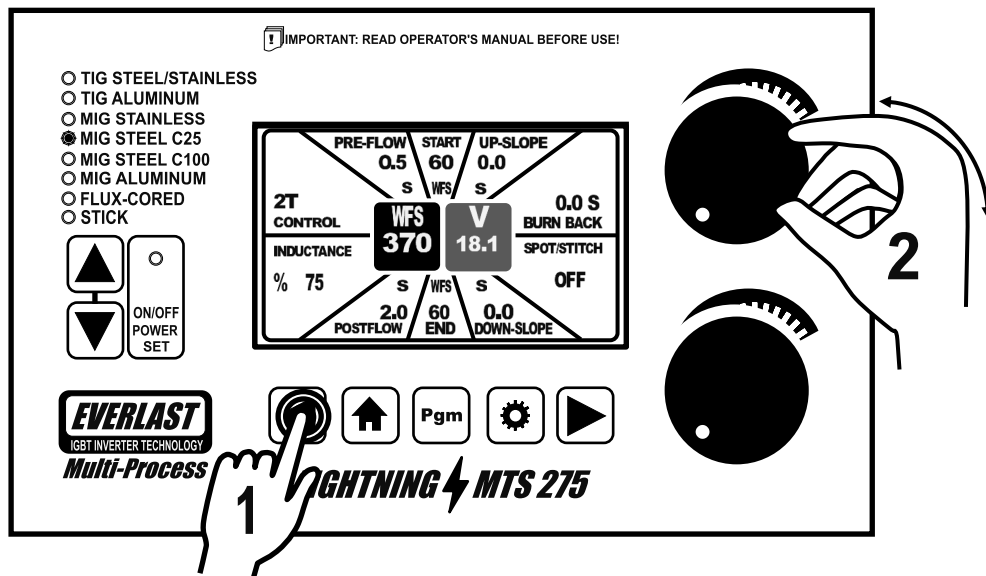

# SETTING UP WELDING PARAMETERS

## SELECTION AND ADJUSTMENT OF MIG/FLUX-CORED PARAMETERS

In all MIG and Flux-Cored wire modes, use both top and bottom knobs to control both Wire Feed Speed and Voltage. The top knob controls Wire Feed Speed and the bottom knob controls Voltage, when in the default position. When the right or left arrow button is pressed, and a segment in the pinwheel is highlighted, the WFS will not longer be highlighted red and adjustment of the WFS will not be possible. The WFS box will change to gray, preventing the top knob from controlling the WFS. However, the Voltage, will always be able to be adjusted regardless of the highlighted function (as long as the unit is still in the main pinwheel menu, and not the 4 way menu). The Voltage box will always be colored gray and is only controlled by the bottom knob.

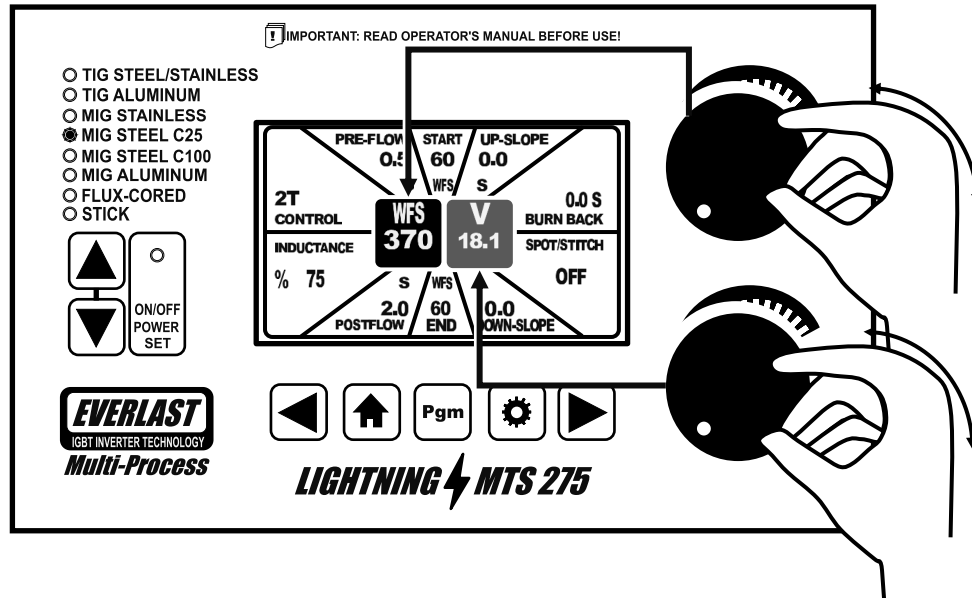

## SETTING UP WELDING PARAMETERS

### SELECTION AND ADJUSTMENT OF MIG/FLUX-CORED PARAMETERS IN POWER-SET MODE



**Important!** Before entering the Power-Set mode, be sure to select and adjust all basic settings such as pre-flow, control method etc. (except WFS and Voltage). The Power-Set mode does not set these functions. It only sets the Wire Feed Speed and Voltage. If at any time an adjustment needs to be made to the basic functions such as pre-flow or wire start speed (run-in) etc., simply drop out of the Power-Set mode to make adjustments and then re-engage the Power-Set mode to continue set-up.

The Power-Set mode offers a guided setup of Volts and Amps, by requiring the user to input wire diameter and also the metal thickness to determine a target setting for both Wire Feed Speed and Volts. The Power-Set mode also takes into account the voltage input, process type selected at startup, whether it is Stainless MIG, Steel C25 MIG, Steel C100 MIG, Aluminum MIG or Flux-Cored.

To enter the Power-Set mode and display the special Power-Set X menu:

- Make any necessary adjustment to the basic functions such as Pre/Post-Flow/Control/ Run-in (Start) or Crater (End) etc.
- Enter Power-Set mode by pressing and releasing the Power-Set button. The LED above the Power-Set button should light up.
- Use the left arrow key to adjust the Wire diameter.
- Use the right arrow key to adjust the Metal thickness (material) that is being welded.
- Use the upper right knob to control Wire Feed Speed (WFS).
- Use the lower right control knob to control Voltage.

**Hint:** If you do not know the metal thickness in inches or in standard gauges, there are apps that can be used to convert.

Once wire diameter and metal thickness have been chosen, the unit will display a target Wire Feed Speed and a target Voltage for welding. The target voltage and wire speed feed is represented by a  $\star$  (4-pointed star) surrounded by a highlighted block located on a long bar in the upper and lower sections of the X menu:  The program settings is based off of a standard flat welding position. Altering welding position may affect the accuracy of this setting. It may necessitate slight readjustment of the Voltage or Wire Feed Speed or both to attain an ideal setting. Other conditions can affect the accuracy such as individual welding preferences, variations in gas formulations, etc. The Power-Set mode allows for fine tuning of both Wire Feed Speed and Voltage. The 4 pointed star will disappear, but the rectangle will move side to side along the bar to represent the deviation from the target as you increase or decrease the value:  OR  The WFS and Voltage value displayed will also increase or decrease at the same time. However, to prevent settings that may yield poor welds, or erratic behavior the amount of adjustment in the Power-Set mode is limited. Think of these limits in adjustment as a type of guards that keeps settings from going too far astray. If you find that you need more adjustment for whatever reason, you may drop out of the X menu and resume full manual adjustment. When welding at the upper range of the Wire Speed and Volt capacity of smaller diameter wires, operation may not be ideal even with the programmed settings.

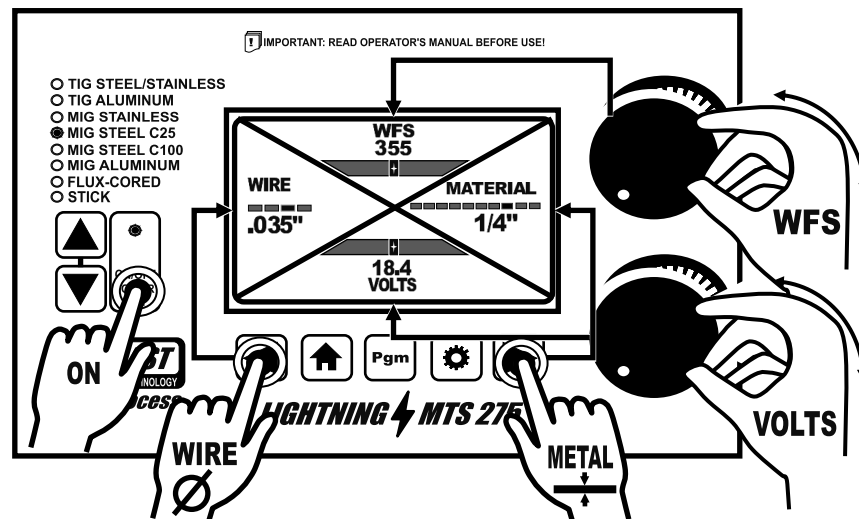

#### NOTICE:

120V operation limits the range of the input variables such as wire speed and or material thickness due to the decreased output of the machine. If it appears that some X menu input selections are limited, double check to see if the unit is plugged into 120V.

# SETTING UP WELDING PARAMETERS

## SELECTION OF 2T/4T CONTROL AND SPOOL GUN OPERATION

To change the way the torch trigger functions and/or select Spool gun operation:

1. Press and release the left arrow button one time to highlight the Control function.
2. Press and release the settings button (gear icon) to access the 4-Way menu.
3. Select the type of operation desired (This is also the menu where spool gun operation is turned on or off) by pressing and releasing one of the arrow buttons until the desired style of control is highlighted. Depending upon selection choice, more than one segment of the 4-Way menu may be highlighted as you continue to press the button.
4. Press and release the home button to return to the main pinwheel menu.

*NOTICE: Access to the 4T setting will be blocked in MIG/Flux-Cored modes if Spot/Stitch is On. Without the Spot/Stitch feature on, you may choose from 2T, 4T, 2T Spool Gun or 4T Spool Gun operation.*

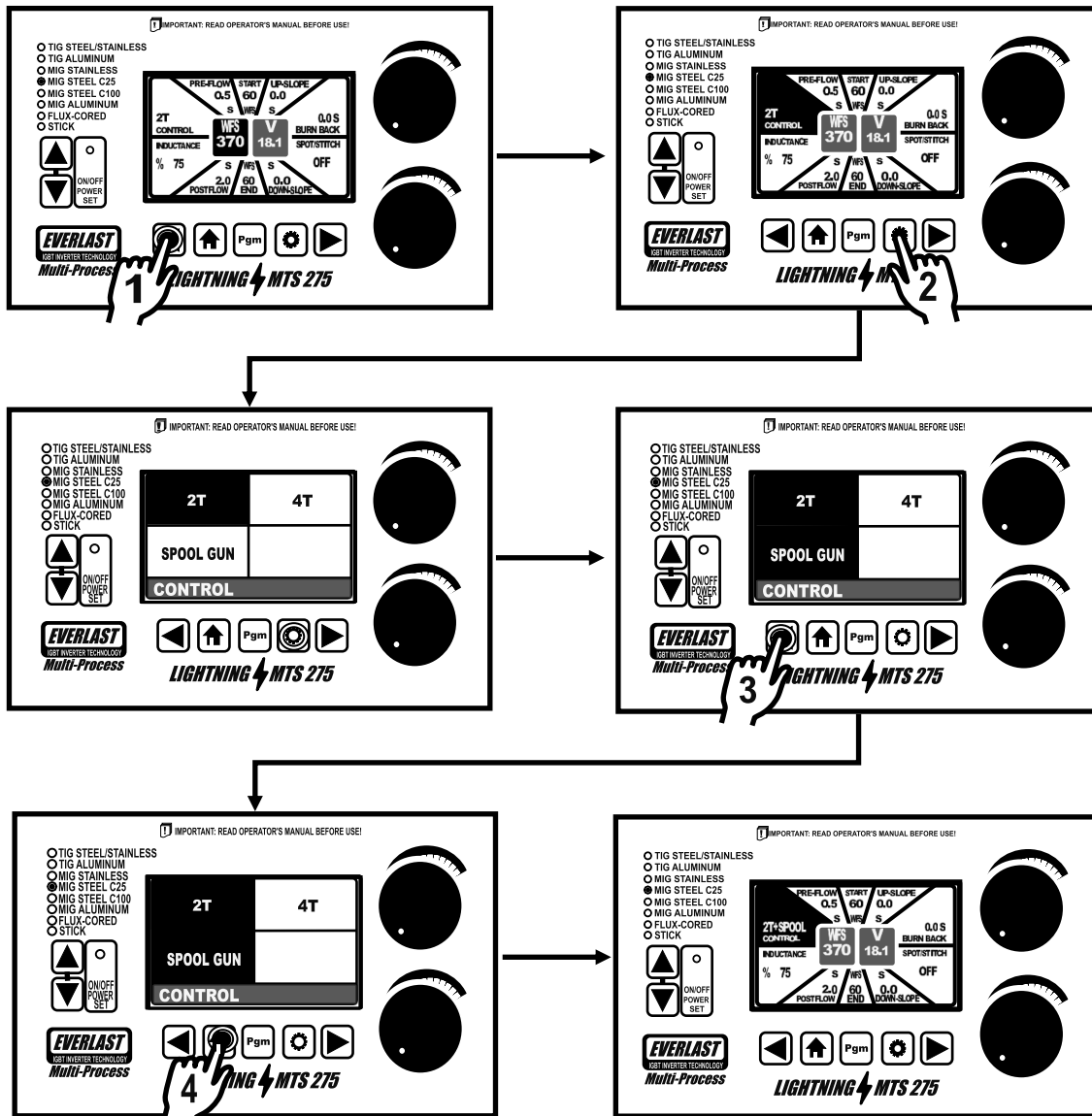

# SETTING UP WELDING PARAMETERS

## SELECTION OF SPOT/STITCH CONTROL

To activate the spot/stitch timer and adjust the settings:

1. Press and release one of the arrow buttons until the Spot/Stitch Timer segment of the pinwheel menu has been highlighted.
2. Press the settings button (gear icon) to access the 4-way secondary menu.
3. Press and release one of the arrow buttons to highlight and select either "Spot/Stitch On" or "Spot Off". Once the timer has been turned on, continue to press and release the arrow button to highlight the desired parameter (Spot or Stitch).
4. Once the desired parameter has been selected, use the top right knob to adjust the value of the parameter.
5. To exit the 4-way menu and return to the main pinwheel menu, press and release the home (house icon) button.

**NOTICE:** If Spot only is desired, set the stitch timer to 0.0 S. Do not set Stitch time without setting a spot time. Turning the Spot/Stitch timer on will limit access to control functions. If you are loading another spool or installing a new gun or fixing a feeding issue, turn the Spot/Stitch timer off. The Spot/Stitch timer, if it is on during this process will stop the feeding of the wire when the timer has timed out. This may mean that only a few inches of wire are fed at a time before the wire stops feeding. If you are experiencing on/off or cycling of the wire feeding, check to make sure the Spot/Stitch timer is not turned on.

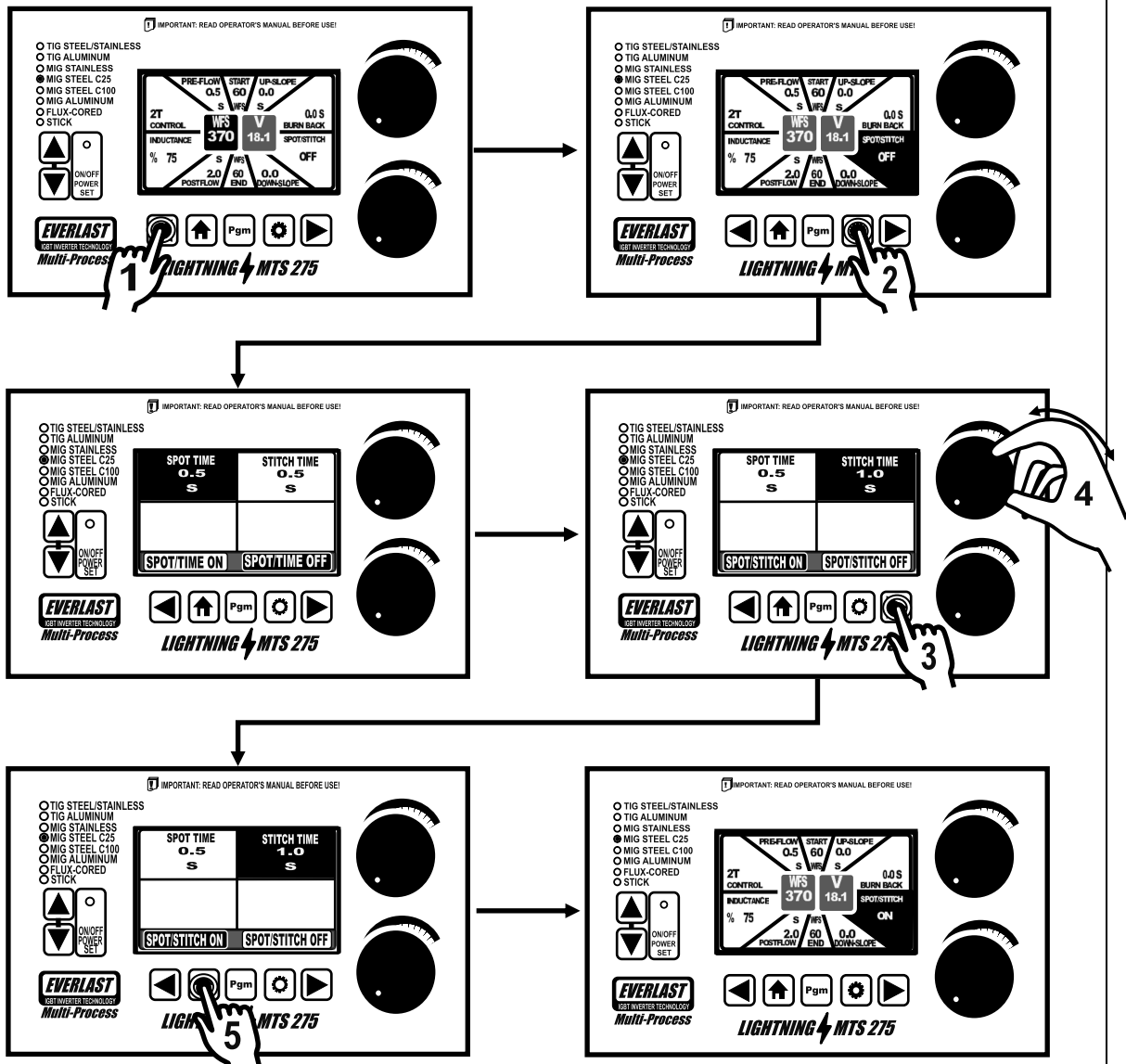

**NOTICE:**

This unit operates multiple classes and sizes of electrodes, including E6010. There are basic differences in how a transformer welder and an inverter welder handle E6010. Inverters, including this one, typically prefer a tight arc for E6010. In fact, the action of the arc force control encourages this type of welding. Where a long arc is used to add extra heat in a weld with a transformer based Stick welder, the opposite is true with an inverter Stick welder.

The rod should be pushed into the weld to provide more heat. Dragging, or a quick, tight stepping motion usually yields best results, especially in open root welding. The arc force increases automatically increases amperage as the voltage falls when the arc is shortened. This helps prevent snuffing of the arc, or sticking of the rod in the weld. Increasing arc Amperage through the arc force setting offsets the loss of Voltage, which helps maintain welding Wattage ( $V \times A = W$ ). Transformers cannot truly maintain a steady heat input due to the rise and fall of arc Voltage as arc length is changed. Admittedly, this is a far different way of looking at things for those that have not been trained this way. In many ways, engineering call outs for specific amperages are meaningless because wattage is constantly varying with changes in arc voltage with transformer welders. However, with inverters and the newer technology they bring to the industry, wattages can be maintained within a defined range because of the offsetting of Voltage loss by the increase of Amps. If you notice a rise in amperage, or a hotter weld than you'd experience with a transformer, this is largely due to the action of the arc force and not a problem with the welder. Although relatively low arc force is needed for iron-powder and titania fluxed rods (i.e. E7014/E7018/E7014) trying to Zero out (set at 0) the arc force will not force the unit to act like a transformer machine. It will only cause arc quality and stability to deteriorate. For these type rods, start by using 20% arc force setting, and adjust from there. For Cellulose fluxed rods, (i.e. E6010/E6011) start with 60 to 80% arc force setting and increase or decrease as needed.

This may require some retraining and disciplined rod manipulation by some users who have learned older techniques, especially those that use long swinging/flogging motions to whip in and out of the weld puddle. At the very least, it will require an exercise of patience for some users to get used to the new technique.

Longer arcs offer more opportunity for porosity and weld inclusions. The shorter arc techniques used recommended for welding with inverters help eliminate this issue. ***For best E6010 and cellulosic performance, use the Power-Set function where the exact class (6011, 7018, 6010 etc.) of electrode and size of electrode can be selected. In manual mode the performance mode for E6010 is not available.*** Manual mode is good for E7018 and other rods, including stainless, aluminum, or specialty rods not listed in the Power-Set menu.

# STICK



## UNDERSTANDING DC STICK FUNCTIONS

### TERMS RELATED TO DC STICK FUNCTIONS

**Amps.** This is the measure of the “flow” of the welder current.

**Arc Force Control.** In stick mode, as arc length drops, so does voltage due to the manual process design. A weld isn't made with only Amperage, Voltage is also involved. Using the formula of  $V \times A = \text{Watts}$ , the output of a welder and total heat drops if either volts or amps are affected. In reality, wattage is a better measure of heat input into a weld. With arc force, as the arc drops voltage drops below 20 volts due to a short arc length, the loss of voltage is compensated for by injecting additional amperage into the weld. This “force” helps to stabilize the arc and allows the unit to maintain an arc and overall wattage. This can make the puddle feel much smoother or more crisp by removing or adding to arc force action.

**Hot Start.** When an arc is struck with stick, the initial arc strike can be difficult. The hot start function can be used similarly to Arc force control to offer a temporary boost in Amperage to improve arc striking efficiency and help reduce porosity at the beginning of the weld cycle. Hot start on this unit is broken into two parts. Hot Start Intensity and Hot Start Time. Hot start intensity is the percentage over the set amps at which the Amps will be boosted during the arc start. Hot Start Time is simply the amount of time that this extra boost stays **engaged** before dropping back to the set welding amps.

**Voltage Reduction Device.** Stick welding usually involves high OCV (Open Circuit Voltage). This relatively high OCV is typically not enough to cause harm in normal welding conditions. However, in conditions where the operator may be in direct contact with the part being welded or where everything is electrically charged by the welding current and the possibility exists that the operator may become part of the circuit path of the welding arc, a Voltage Reduction Device VRD may be required. The VRD on this unit is built into the programming and drops OCV to around 14-15 Volts. The VRD can make arc starting more difficult, but when and where it is required, can prevent the unlikely, but possible event of severe shock or electrocution.

## SETTING UP WELDING PARAMETERS

### STICK FUNCTIONS AND PARAMETER SELECTIONS

#### STICK SELECTION

To begin, select the STICK option by scrolling through the left menu array of LEDs. The LED will light and the following screen will display briefly. Since there is no shielding gas involved with Stick, the unit reminds the user that the electrode has become live with "OUTPUT ON".

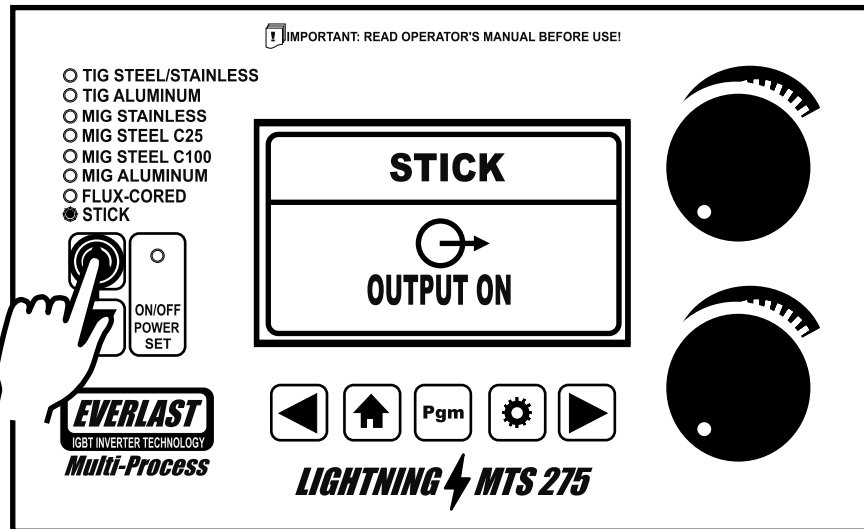

#### SELECTION AND ADJUSTMENT OF STICK PARAMETERS

1. Once the process has been selected, use the right or left arrow button to select the desired parameter for adjustment. The selected parameter on the pinwheel menu will change color and be highlighted and ready for adjustment.
2. Rotate the top right knob to increase or decrease the parameter value.

**NOTICE:** One pinwheel segment OR square box will always be highlighted. The default highlighted position is the welding Amperage. This allows the top knob to control any highlighted parameter value. It is not necessary to return to the default welding Amperage position to weld, but it is a good idea to do so. This will allow on-the-fly adjustment of welding Amperage if needed. The Voltage block segment is not adjustable and is used for a reference for actual Open Circuit Voltage and Arc Voltage only.

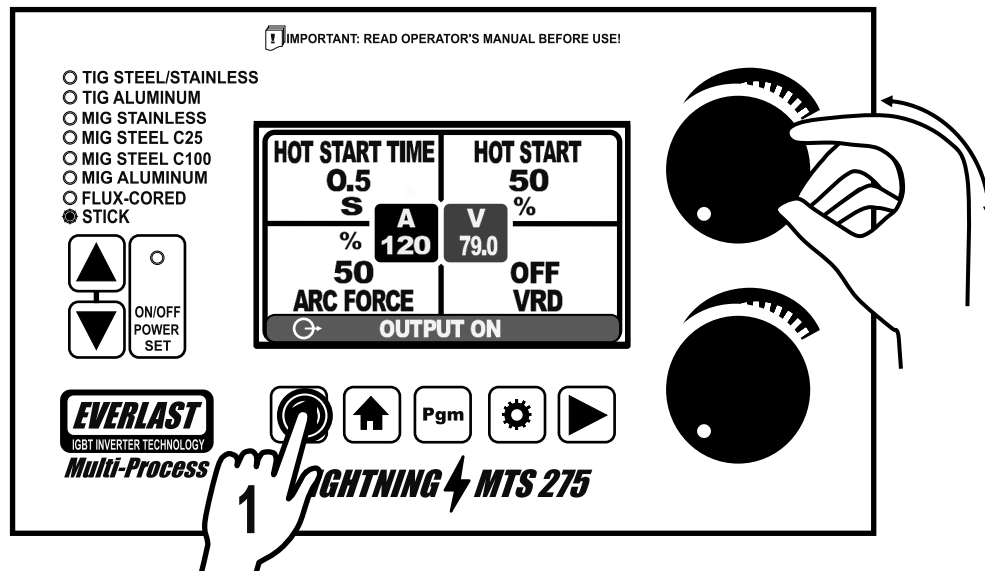

## SETTING UP WELDING PARAMETERS

### SELECTION AND ADJUSTMENT OF DC TIG (TIG STEEL/STAINLESS) IN POWER-SET MODE



**Important!** Before entering the Power-Set mode, be sure to select and adjust all basic settings such as pre-flow, control method etc. (except Amps). The Power-Set mode does not set these functions for you. **If at any time an adjustment needs to be made to the basic functions such as pre-flow, control type, start Amps etc., simply drop out of the Power-Set mode to make adjustments and then re-engage the Power-Set mode to continue the set-up process.**

The Power-Set mode offers a guided setup of Amps, by requiring the user to input Tungsten diameter and also the thickness of the Aluminum to determine a target setting for the Amperage. The Power-Set mode also takes into account the input voltage input to determine parameter input and output limits of some functions.

To enter the Power-Set mode and display the special Power-Set **X** menu:

- Make any necessary adjustment to the basic functions such as Hot-Start Time, Hot Start Intensity, and Arc Force.
- Enter Power-Set mode by pressing and releasing the Power-Set button. The LED above the Power-Set button should light up.
- Use the left arrow key to select the electrode type and diameter.
- Use the right arrow key to adjust the thickness of the weld metal that is being welded. (The selections for thicknesses will change with rod diameter changes)
- Use the upper right knob to control Amperage.
- The lower right knob is inactive in this Mode.

**Hint:** If you do not know the metal thickness in inches or in standard gauges, there are apps that can be used to convert.

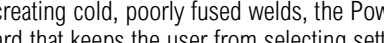
Once rod type/diameter and metal thickness have been chosen, the unit will display a target welding Amperage in the upper, center display. The target Amperage is represented by a ✦ (4-pointed star) surrounded by a highlighted block located on a long bar in the upper section of the **X** menu:  The programmed Amperage is based off of a standard flat welding position. Altering welding position may affect the accuracy of this setting. It may necessitate slight readjustment of the Amperage to fine tune the target setting. Other conditions can affect the accuracy such as individual welding preferences, rod brand, etc. When deviating from the target Amp setting, the 4-pointed star will disappear. The rectangle will move side to side along the bar to represent the deviation from the target as you increase or decrease the value:  **OR**  However, to prevent setting the Amps too high, burning up the electrode, or too low, creating cold, poorly fused welds, the Power-Set mode is limited in adjustment. Think of these limits in adjustment as a type of guard that keeps the user from selecting settings from going too far astray. If you find that you need more adjustment for whatever reason, you may drop out of the **X** menu and resume full manual adjustment. However, for E6010, and E6011 operation, use the Power-Set mode. In cases where no identical match to electrode is found, select a rod type that most closely matches. For example, for E7014, the user could select 7018.

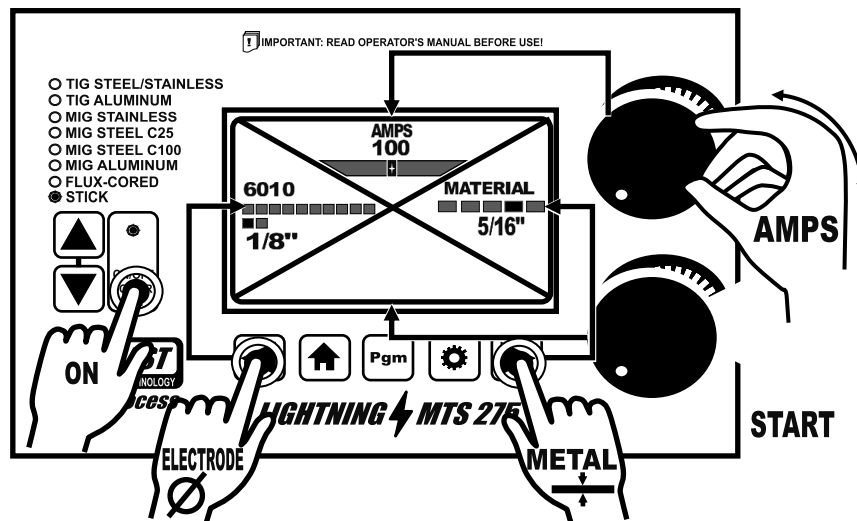

#### NOTICE:

120V operation limits the range of the input for material thickness due to the decreased output of the machine. If it appears that some **X** menu input selections for material thickness are limited, double check to see if the unit is plugged into 120V.

## SETTING UP WELDING PARAMETERS

## SELECTION OF VRD

To activate the VRD (Voltage Reduction Device):

1. Press and release one of the arrow buttons of the main menu until the VRD segment is highlighted.
2. Press and release the settings button (gear icon) to access the secondary menu.
3. Press and release one of the arrow buttons to select either ON or OFF.
4. Press and release the home button (house icon) to return to the main menu.

**NOTICE:** The VRD function is used to reduce the OCV of the unit. In some applications and job environments, VRD is required for safe operation, lowering the risk for shock or electrocution when high potential exists for the user to become a circuit path for the electric current. VRD can reduce first strike starting efficiency when trying to start a welding arc. A quick double tap of the electrode helps to get the arc started much quicker. Be sure to check safety requirements on the job site to determine if VRD is necessary or not. VRD will change the voltage value.

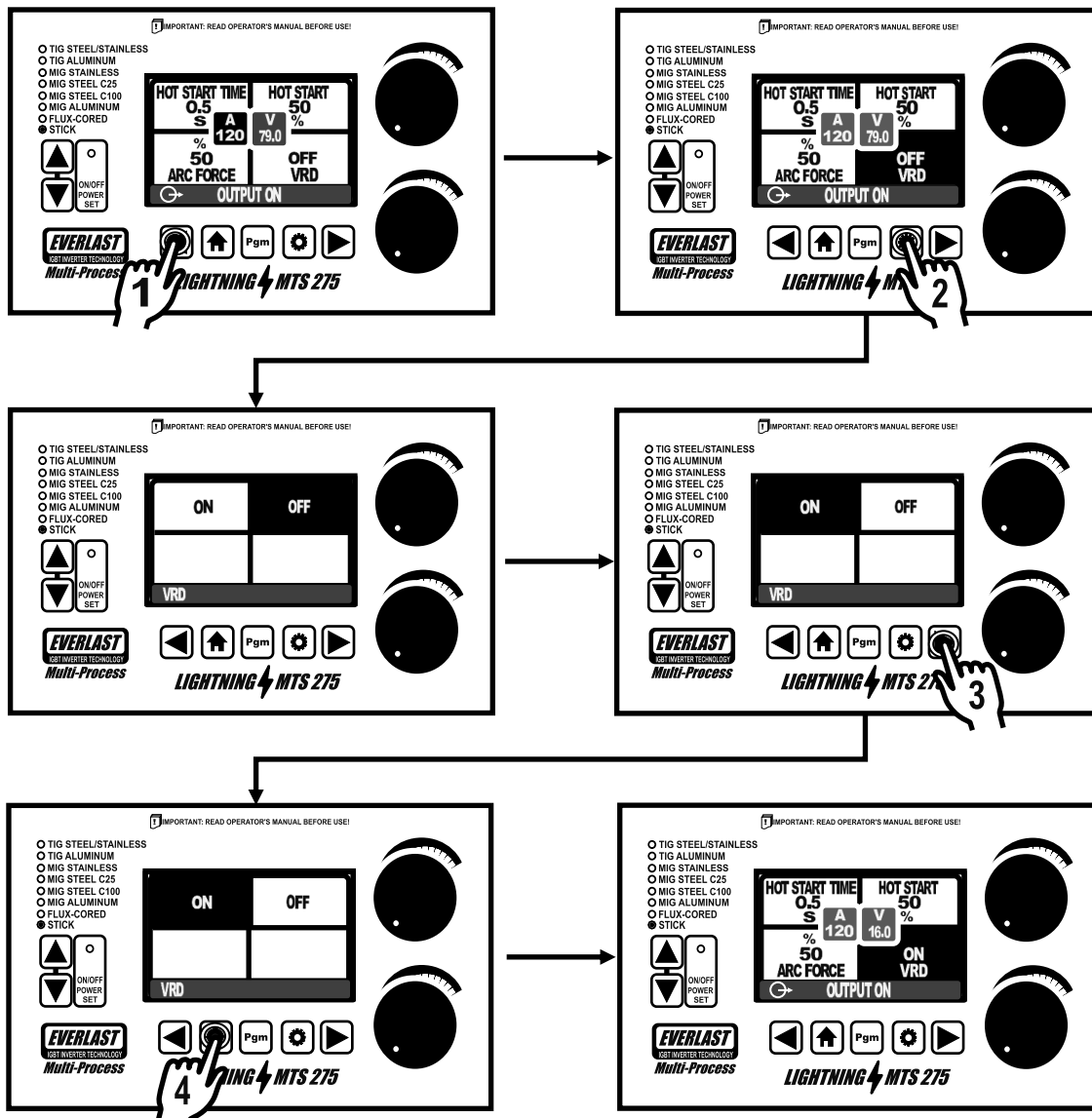

# PROGRAM/MEMORY

## SETTING UP WELDING PARAMETERS

## SAVING PROGRAMMED SETTINGS

This welder provides a programmable memory function, which allows up to 16 individual, customized programs to be saved. Any process can be saved.

To save settings:

1. Make any necessary adjustment to the desired program.
2. Press the Program (Pgm) button to access the program menu.
3. Use one of the arrow keys to select a number where the program can be saved. (Default saved programs can be saved over. The default programs are place holders.)
4. Press the Program button again and hold for 3 to 4 seconds to save the program. The new program will be saved over the old program.
5. Press home to return to the pinwheel menu.
6. To recall a program, Press program button and select desired program with an arrow key.
7. Press the Program button again to open the program.

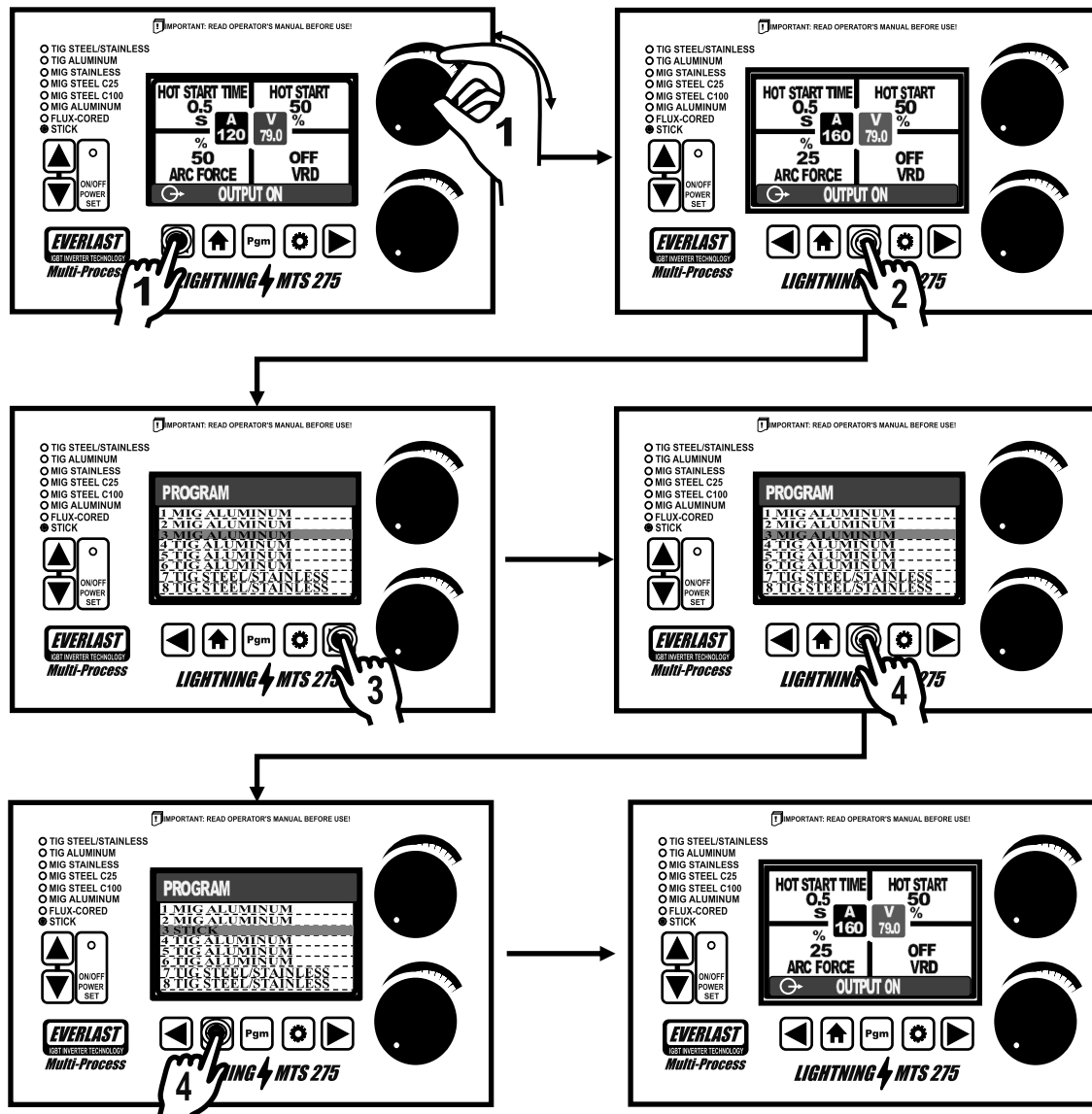

## SETTING UP WELDING PARAMETERS

## RECALLING SAVED PROGRAMMED SETTINGS

This welder provides a programmable memory function, which allows up to 16 individual, customized programs to be saved. Any process can be saved.

To recall previous settings:

1. Press and release the Program (Pgm) Button to enter the program mode.
2. Press and release one of the arrow buttons to highlight the desired program number.
3. Press and release the Program button to recall the saved program.

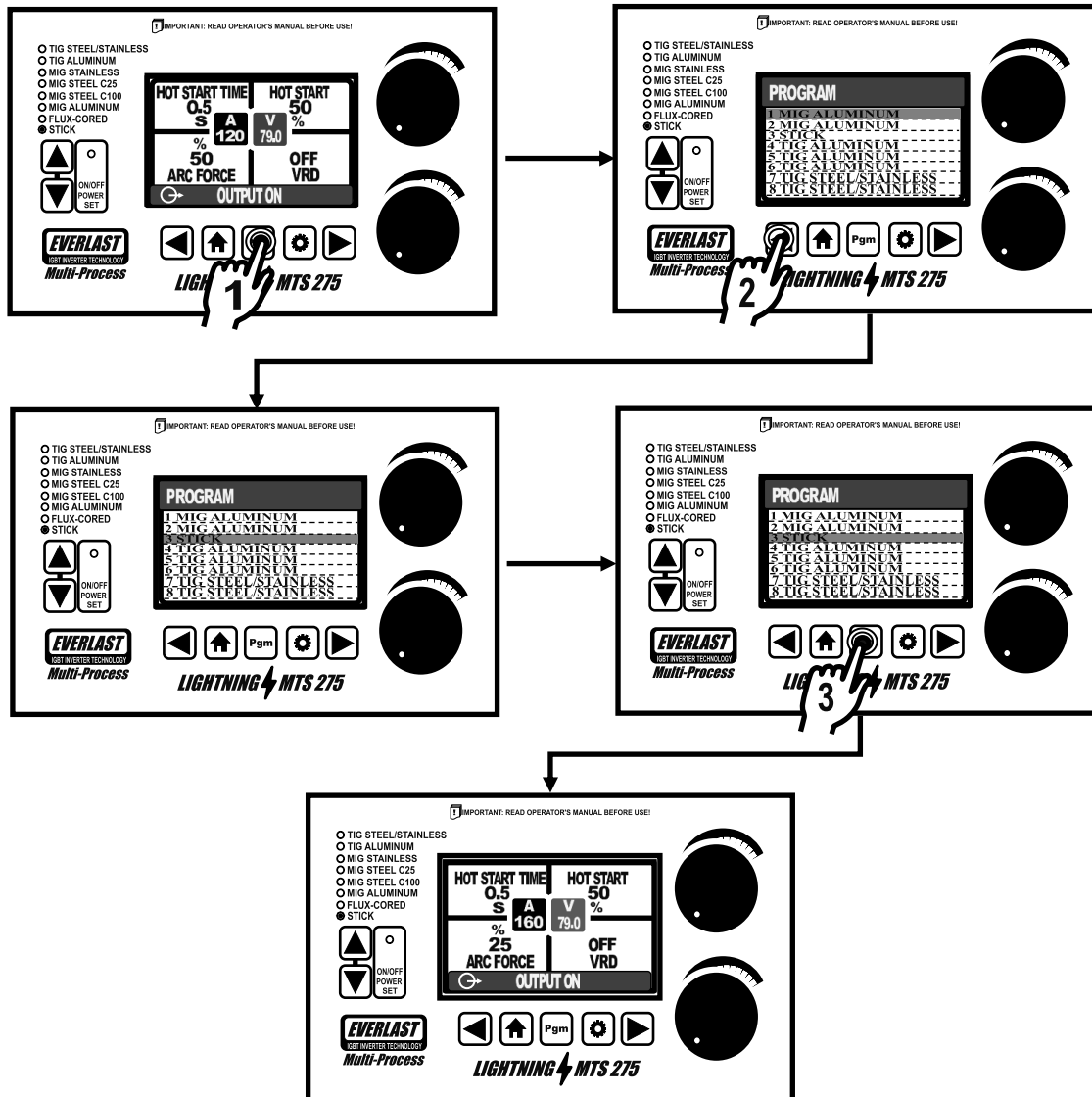

FRONT PANEL LIGHTNING MTS 275





## FRONT PANEL LIGHTNING MTS 275

## FRONT PANEL FEATURES

1. **AC Connector.** The DINSE 35 Style connector is an industry standard sized connector. This terminal has one use only. It is designed to be used only in AC TIG mode. When AC TIG welding mode is selected, the work clamp should be relocated to this terminal. The TIG torch will remain in the negative. **Warning: Never use this connection with the TIG torch or any other torch or mode of operation except AC TIG or damage may occur.**
2. **Control Connector.** This connector serves different functions in different modes. In TIG mode this connector is used to provide arc initiation in TIG mode. When the TIG torch switch is connected, it conveys the 2T/4T signal to operate the sequencer ( controls preflow, start amps, upslope, welding amps, downslope and end amps) When the foot pedal is connected for TIG mode, it serves not only to start the arc, but to regulate the amps. The foot pedal sends a signal to the welder to start the arc and a signal that tells the welder what relative position the foot pedal is in to increase or decrease the amperage. *In spool gun mode it serves to regulate the wire speed and initiate the arc. The control knob on side of the gun is used to change welding wire delivery speed, thereby regulating the amps.* The Gun trigger signals the welder to start feeding the wire, and to initiate the arc.
3. **Control Connector.** This connector is used to connect to the foot pedal in TIG mode, and the Spool Gun in MIG mode. This connector should be disconnected in MIG and Stick mode for safe operation.
4. **Positive Connector.** The DINSE 35 Style connector is an industry standard sized connector. The polarity of the terminal is always positive. This terminal is used as the torch (electrode holder) connection in stick mode. In DC TIG mode this is the location of the work clamp. This is used as the work clamp location, only while in DC TIG mode. In AC, mode the work clamp will be transferred to the AC Connector.
5. **Gas Connection.** This is the gas connection when welding in TIG mode. The quick coupler is designed to offer quick and efficient coupling of the TIG torch gas line. If you are using a water-cooled torch, before attempting to connect the gas line, blow through the gas line to verify that gas does indeed exit through the torch head. Otherwise, improper gas connection may occur.
6. **Euro MIG Connector.** The MIG gun and Spool gun connect directly to this fitting. The connection offers quick and secure fitting of the MIG gun or spool gun directly to the unit. To secure the Gun to the fitting, align the small pins and large gas conductor fitting and slide together until it completely seats home. Then, gently screw the outer plastic hand nut on the torch connector clockwise until the fitting is secured. Do not overtighten or use any tool or pliers to further tighten the nut or damage may occur. Hand tight is sufficient.
7. **Clear Plastic Protective Cover.** When the machine is in use, keep this protective cover down to prevent spark damage or UV damage to the panel from intense arc rays. When not in use the panel should remain down as well. The only time the panel should be raised is during

SIDE ACCESS PANEL LIGHTNING MTS 275



## SIDE ACCESS PANEL LIGHTNING MTS 275

## SIDE PANEL FEATURES

1. **Spool Carrier.** The spool carrier is designed to carry full-size spools of wire 12" in diameter, and up to 44 lbs. It can also be used with the supplied adapter to carry 8" diameter spools with the supplied adapter. *Hint: With some brands of smaller 8" rolls the adapter locating pin may be too long to fit properly. Take a file, or small grinder or saw and take off a small amount of the locating pin until the spool fully seats and the door is able to close without rubbing.*
2. **MIG/Flux-Cored Polarity.** This is where the gun polarity is changed. Work Clamp polarity is changed on the front of the panel. For MIG, the cable should be connected to the positive (+) terminal. For Flux-Cored, the cable should be connected to the negative terminal.
3. **Four Roll Drive Feeder.** The wire feeder features 4 driven rolls. Only the bottom feature removeable rolls. Drive rolls must be matched to the size and type of wire being fed. Order additional drive rolls from Everlast if needed.
4. **Panel Door.** This door should be kept closed while in use to prevent access to moving parts.

# REAR PANEL LIGHTNING MTS 275



## REAR PANEL LIGHTNING MTS 275

## REAR PANEL FEATURES

1. **Gas Supply.** The Lightning MTS series unit is equipped with dual gas inlets. The top should be connected to pure Argon for TIG. The bottom should be connected to the appropriate MIG gas. This is a standard 5/8 CGA inert gas female fitting. The unit is supplied with one regulator, but the two inlet setup allows for installation of 2 regulators at the same time. One is for MIG, and the other for TIG. If using only one regulator, keep one of the supplied plastic caps installed to prevent dirt entry into the solenoids. Upon installation of the regulator, check for leaks in the regulator tubing. If a leak is found, install extra clamp if needed to prevent gas from escaping.
2. **Power Switch.** Turns unit on or off. This is a 2 pole single phase 240V breaker-type switch. If it is switched to the left, this means the unit is switched off. If it is switched to the right, and the unit is plugged into a good power supply, the unit should power up. **Note: When switched off, the unit will continue to run and appear to be switched on for up to 10 seconds as the capacitors discharge. This is normal.** However, if the unit will not switch off for some reason, the switch may be damaged. Turn off the unit at the main circuit breaker, and contact Everlast technical. Do not continue to use.
3. **Power Input Cable and NEMA 6-50P Plug.** The Lightning MTS unit requires 120/240 V single phase 50/60 Hz power input. If necessary this unit will operate on 208V input as it is within the 10% voltage allowance. If actual voltage is below 205 volts, the unit may not function correctly. If used on a generator, the generator must be labeled as "clean power" and provide less than 5% THD. Consult your generator manufacturer for information regarding the clean power rating on specific units. Everlast does not provide a list of approved generators. Manufacturers rate their units as clean power independently according to industry standards. The plug is the NEMA 6-50P. This is the standard plug for welders operating on 240V in the US and Canada. Other countries will have different configurations. For operation with 120V, use the supplied adapter.
4. **Fuse. 10A, Fast-blow. F10AL, 250V.** This controls the main power to the panel and fans. If the unit suddenly stops, and no power to the panel is observed and the fans are not running, first check the main circuit breaker at the power panel and the power switch position on the back. Reset if necessary. If power isn't restored check this fuse. It's a standard fast blow glass type fuse available at many auto parts and electronic supply stores. Fuses can blow from overloading, circuit defect or simply from operation over time. If the wire feeder quits feeding, and all other signs are correct, it may be another fuse issue.
5. **Fans.** The unit is equipped with a 4 fan system, which offers quieter and more efficient cooling. It must operate free of obstruction to preserve the high duty cycle which it offers. Keep all objects or restrictions at least 12" from all sides of the unit for proper cooling. If possible allow 18". Allow the unit to rest on the rubber pads/feet mounted on the welder. Do not have the bottom of the unit supported directly on the metal pan so air can circulate around the bottom as well. Do not run in an enclosed space such as a cabinet or work box. Do not grind or weld where sparks are directed toward the rear of the unit or metallic particles will build up on the fan blades and also on interior components. If metal builds up on the fan blades, it can cause them to vibrate and ultimately fail.
6. **Ground Bolt.** The unit is equipped with an additional grounding point for applications requiring a bonded ground. Under most conditions, the use of the ground is not required. Consult a local licensed electrician for installation and use of this connection.
7. **Water-Cooler Plug.** (NA on early models) This is a 240V cooler plug designed for use with Everlast Water Coolers. Do not use this plug for any other application. This is a low amperage outlet and is not designed to power any tools or other accessories. The Power-Cool 400 water cooler is recommended for this unit. It is designed to stack under the Lightning MTS 275.

# 36 SERIES MIG TORCH

## Expanded View

15	IFT0063	SCREW M4x6 UNI 6107	1		22	ICU0005-10	Contact Tip 1.0/M8x30	1					
14	IHJ0645	Back Box Hole	1		21	IFT0167	LABEL ERGO 36KD	1					
13	IFT0897	SPRING FOR CABLE SUPPORT/BLACK	1		20	ICG6000	SPANNER FOR MIG	1					
12	IHO0050	INSULATOR TUBE/#5 M	0.13m		19	ICG0590	Insulated Steel Liner 1.2-1.6 3.4m Yellow	1					
11	ICN0670	COAXIAL CABLE 4.2mmq 3m	1		18	IZT0071	Liner Nut	1					
10	IZH0864	Joint With Spring	1		17	ITB0059	Euro Central Adaptor Body/Spring pins	1					
9	IHJ0715	HOUSING FOR HANDLE	1		16	IHJ0070	Gun Plug Nut	1					
8	IFT0874	SCREW D.3x10 UNI#707	3				serial number    drawing number    name    quantity    note						
7	IHO0070	TRIGGER RED	1				range of tolerance						
6	ICV0757	MIG HANDLE BLUE/INNO/GRIP	1				ICT2998-26	a=6	6+a-30	30+a-120	a=120		
5	ICZ0089	Torch Head 36KD	1					±0.1	±0.2	±0.3	±0.5		
4	ICF0562	White Ceramic Gas Diffuser 36KD	1		marking	places	Revised file No	Signature	date	description			
3	ICU0687	Contact Tip Holder 36KD M8 32mm	1		designer		Standardization			reference number	material	weight	edition
2	ICU0005-12	Contact Tip 1.2/M8x30	2		drafted		craft			MIG 36KD Torch 3m With Spring Pins/INO HANDLE/OLD BACK BOX			
1	ICS0072	Gas Nozzle Ø16 36KD	1		proofread		approval			page one	one page in total		
serial number		drawing number		name		quantity		note		2016-08-15			

### NOTICE:

Over time, pressure on the drive rolls causes metal fragments from the filler wire's surface to find its way to the gun cable liner. If the wire guide is not cleaned, it can gradually clog up and causes wire feed malfunctions.

**If feeding difficulty is observed, clean the liner in the following manner:**

1. Remove the welding gun's gas nozzle, contact tip and contact tip's adapter.
2. With an air nozzle blow compressed air through the wire guide. Wear eye protection!
3. Blow out the wire feed mechanism and reel housing with dry compressed air.
4. Reassemble components. Tighten the contact tip and contact tip's adapter with the spanner included to ensure tightness. Do not overtighten any fittings or stripping of the threads may result.

The MIG torch liner may eventually become worn and will need to be replaced. When welding aluminum with the main gun, a Teflon liner must be used, necessitating a liner change. A spool gun is the preferred method to weld Al, but a polymer liner may be used with guns 10ft and under to weld aluminum. In this case, you will need to change the standard liner intended for steel use to feed directly from the machine.

**To change the liner:**

1. Remove the securing nut of the liner (#17) which exposes the end of the wire guide.
2. Straighten the gun cable and withdraw the liner from the gun.
3. Carefully push a new wire guide in to the gun. Make sure that the wire guide travels all the way to the contact tip.
4. Make sure the O-ring at the machine-end of the gun is installed
5. Tighten the wire guide in place.
6. Cut the liner 2mm from the mounting nut and file the sharp edge of the liner.
7. Reattach the gun and tighten all parts.
8. Re-thread wire.

### EXPANDED VIEW OF TIG TORCH

(Actual appearance may vary slightly from what is listed.)

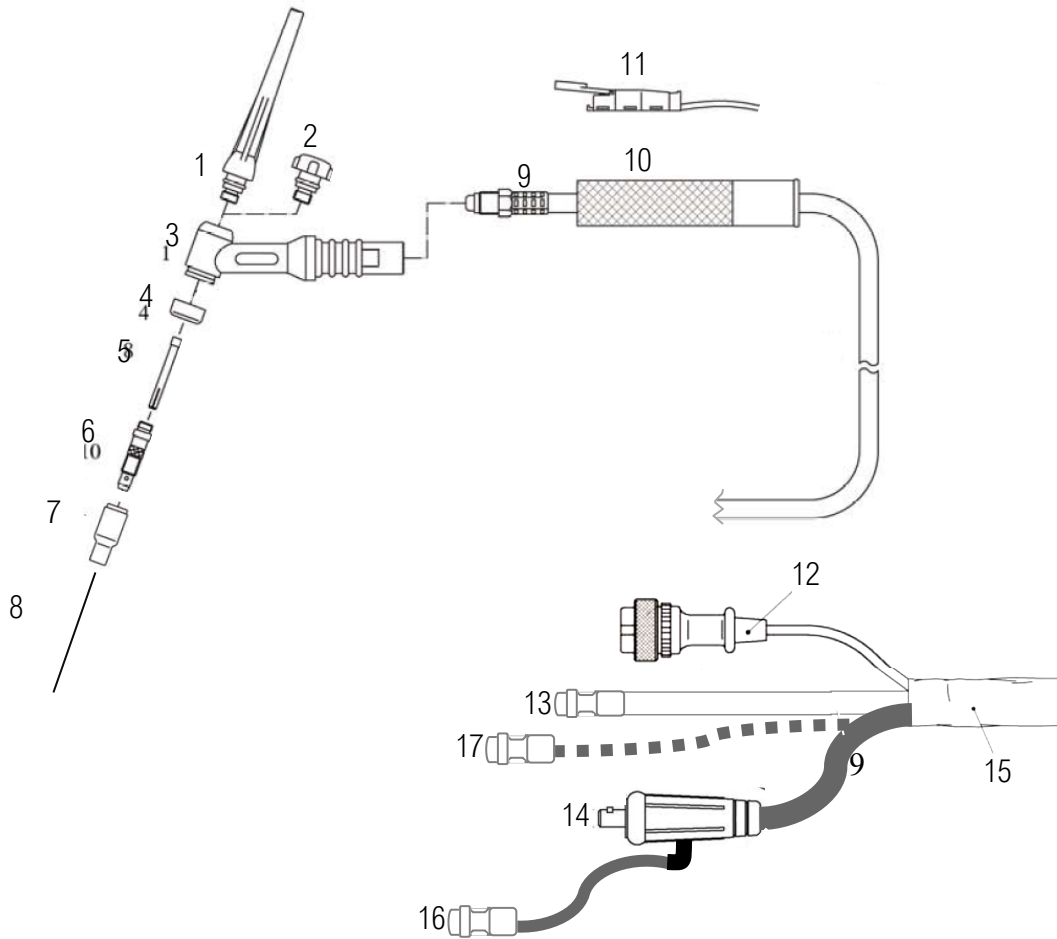

NO.	TYPICAL PARTS FOR 18 Series Torch ( STYLE MAY VARY)	QTY.
1	Long Back Cap with O-Ring	1
2	Short Back Cap	Opt.
3	Torch Head	1
4	Insulator	1
5	Collet 1/16 or 3/32	1
6	Collet Holder	1
7	Ceramic Cup #4, 5,6, or 7	1
8	Tungsten (customer supplied)	0
9	Torch Cable	1
10	Torch Handle (Blue ergo handle std, not pictured)	1
11	Torch Switch (Built into ergo handle, separate on straight handle)	1
12	Torch Switch Connector	1
13	9mm (1/8") b quick connect coupling (male) (Water IN, 20 series)	1
14	Power Connector	1
15	Protective Cove (Denim, synthetic rubber or nylon)	1
16	Gas IN (9 series) / Water OUT (20 Series)	
17	Gas IN (20 series only)	

## MIG OPERATION AND THEORY

**General Setup of Amps and Volts.**

When welding in standard with the Lightning MTS, the two main functions that require adjustment are Voltage and Wire feed speed. The function of voltage in MIG welding is to control the overall width and to a great extent, the height of the weld bead. In other words, voltage controls the bead profile. The wire feed speed directly controls the amps, and in turn amps control penetration. When setting the welder up you will notice that the WFS (Wire Feed Speed) is displayed in Inches Per Minute. For MIG, Amp output is controlled with through control of the wire speed, so one is related to the other. But Amps are not exactly the same thing since wire feed speed, wire diameter, and wire type all figure into the Amp equation. The relationship between wire diameter, wire speed and amps is easily figured with the following approximate industry conversions for steel:

.023":  $3.5 \times \text{Amps} = \text{Inches per minute (IPM)}$   
 .025":  $3.1 \times \text{Amps} = \text{Inches per minute (IPM)}$   
 .030":  $2 \times \text{Amps} = \text{Inches per minute (IPM)}$   
 .035":  $1.6 \times \text{Amps} = \text{Inches per minute (IPM)}$   
 .045":  $1 \times \text{Amps} = \text{Inches per Minute (IPM)}$

To convert wire speed (IPM) into approximate Amps, use the following conversion formula:

.023":  $\text{IPM} \div 3.5 = \text{Amps}$   
 .025":  $\text{IPM} \div 3.1 = \text{Amps}$   
 .030":  $\text{IPM} \div 2 = \text{Amps}$   
 .035":  $\text{IPM} \div 1.6 = \text{Amps}$   
 .045":  $\text{IPM} \div 1 = \text{Amps}$

Keep in mind these are approximate conversions and do fall off in accuracy as amps are increased into the upper current limits for the given wire diameter.

Even though you will find general recommendations about setting the Amps, Volts and even shielding gas through a variety of free downloadable apps and online calculators, every filler metal manufacturer has its own specific parameters for Volt and Amp settings for each wire diameter and class of wire. The ranges of volt and amp parameters generally varies somewhat from brand to brand, so be sure to read the packaging and/or manufacturer literature to determine what range of settings are recommended. The wire diameter also limits the practical maximum thickness of what can be reasonably welded. The issue with following charts, graphs and calculator recommendations is that most people find them either too hot or too cold. For some people, it may not even close. However, nothing can substitute for watching the arc and listening to the sound of the arc. A crisp, steady sound, frequently referred to as a "Bacon frying sound" should be heard. The actual frying sound can vary somewhat and may have somewhat of a high pitch whine to it somewhere between the sound of a flying bee and a mosquito. If these sounds are present, look at the arc to see if it is

steady, and producing low amounts of spatter. If large amounts of spatter are present, the puddle seems fluid (appears wet) and the wire speed is within the targeted range, decrease volts a little at a time to reduce the spatter. If this does not correct the problem, change the torch angle and torch height. Hold the torch more vertical, with less than a 15 degree deviation from vertical and reduce stick-out of wire to 3/8" or less. If this still does not help, reduce the wire speed. Some spatter is normal, though it should be minimal overall.

The wire can also pop and spatter if the voltage is too low for the wire speed and/or wire diameter. This is mostly observed as flying bits of red-hot but un-melted wire, along with popping as the wire inconsistently stubs into the puddle. This is followed by the wire pushing back against your hand pressure while the wire visibly turns white/red hot before burning off. Too low of voltage will also produce a high piled bead with the toes (edges) of the weld not properly wetting in resulting in poor fusion.

**Inductance**

The third important variable in setting up the Lightning MTS is the Inductance control. This third adjustment can greatly vary the feel of the arc at any given volt and amp setting. It is used to balance the stiffness of the arc against the wetness of the arc. Some professionals refer to the "buttery-ness" of the arc. "Buttery-ness" is arguably somewhat a subjective term. However, it generally refers to how smooth and fluid the arc feels and looks. In fact, the inductance alone can affect how much wire speed or voltage is needed in any given application. It does not typically require altering of the Volts or the Wire Speed settings. However the arc force control can expose poorly selected Volt/Wire Speed parameters by magnifying the effects.

While Everlast uses the term "arc force", it is known by many different terms. Often it is referred to as inductance, choke or slope. Simply put, the arc force (Inductance) adjustment controls how long it takes the current to recover and rise to the established welding current to melt the wire after the wire contacts the puddle and the current falls. This process is happening many times a second so it isn't visible to the naked eye. But the overall effect is visible as the wire burn off height is changed and a change in the wetness of the puddle and how easily the molten metal flows in toward the toes of the weld as it melts off. If the unit has sufficient arc force, the edges of the weld will easily wick into the puddle with little or no spatter with little or no manipulation of the torch required. The pitch of the arc will be medium. With too much inductance the puddle may be uncontrollable and the arc will have a throaty, raspy sound. Too little inductance and the puddle will be narrow and possibly have a high ridge in the center. The pitch will be very high and the puddle will seem sluggish and less fluid.



## MIG OPERATION AND THEORY

All MIGs have a preset inductance that is inherent in the machine's design. However, few MIGs have an adjustable inductance. Inductance is part of the personality of a MIG welder. It's one reason that some people prefer the arc of one brand over the other as people develop personal preferences in arc performance. With that in mind, having an adjustable inductance serves several functions:

- 1) The inductance allows the user to dial the machine to a performance level that the user is accustomed to. This helps if multiple users are present and improves the operator's performance with the welder.
- 2) The inductance can help improve control and weldability in out-of-position welds (weld positions other than flat) without having to change other parameters.
- 3) Different shielding gases require different levels of inductance for optimum performance. The inductance improves performance with different gas mixes by being able to adjust the setting to render the best and smoothest possible arc for the shielding gas being used. This is especially helpful when pure CO<sub>2</sub> is used when less inductance is used for spatter control.
- 4) The inductance can improve weldability of thinner metals without having to step down a size in wire. While ultimately there are limits to what any given wire can weld on the lower end of its range, it does help improve the low amp welding characteristics of the wire diameter.

For the best possible experience welding with Lightning MTS welder, adjust inductance after the wire speed and voltage have been tuned. This will keep the user from constantly having to hunt for the best balance of the other two adjustments. Usually once a particular inductance setting is selected that is suitable to the user, it will work well throughout the range of adjustments and will rarely require readjustment once set to the operator's satisfaction. However, this is not to say that readjusting the inductance from time to time is not beneficial. When the operator must weld out-of-position, readjusting the arc force control can help reduce clogging of the nozzle and even make the puddle more controllable. Welding extremely thin materials such as muffler tubing can also benefit from a lower inductance setting.

*Avoid the setting inductance control at any extreme setting without performing a few test welds first.* Few users will find these settings to their liking. Turning the inductance to the minimum setting does not turn the feature off. A suggested starting point would be approximately 70% with mixed gas on steel. This will usually produce a desirable arc with for most people and will produce minimal spatter. Fine tune the adjustment from there, increasing in half increments to find the best performance.

### **Burn Back Control.**

After the trigger is released on the welder, it's natural for a small extra amount of wire to coast out of the gun. This

small amount of extra wire may stick fast in the weld as the molten puddle begins to cool. This will require the operator to break it loose and spend time trimming the wire. Even if the wire does not stick in the puddle, it will often be left sticking too far out from the contact tip for a proper restart. Trimming is usually required with a pair of MIG pliers or wire cutter before restarting the arc. With burn back control, however, the arc can be kept energized long enough to continue supplying power to the wire long enough to burn the wire back to the desired length after the wire stops feeding. The timer control located under the cover sets the length of time the that the arc remains on after the trigger is released.

If the burn back control is set too long it can cause the wire to burn back into the tip itself and welding of the wire to the tip. Begin with setting the unit for a little less than a quarter second. If the burn back control is set correctly, it will leave about 1/4"-3/8" wire sticking out beyond the contact tip. If a large ball develops on the end of the wire, reduce the burn back time so that it creates a balance between ball size and stick-out. Set a Post-Flow that is at least equal to the burn-back time This helps control balling and prevents oxidation during burn back. This is a unique feature that is not found in many welders with burn back control. Burn back control without post flow can cause erratic restarts due to the oxidized or over-balled wire tip.

Even with the burn back control properly adjusted, due to operator error, an occasional quick trim of the wire may be necessary for best arc starts. But overall, when used in a production setting or in a fabrication shop, the burn back control can save on labor and aggravation.

### **Starting the Arc and Welding.**

Starting the arc is a relatively simple process. Before beginning, the wire should initially be trimmed to between 1/4 to 3/8". Once the wire is trimmed, the gun should be firmly grasped to prevent a phenomenon often referred to as "machine gunning". A light grasp, especially at start, can cause the arc to stutter as the wire pushes back on the gun, lengthening the wire stick-out and creating an irregular start and a porous weld. If the arc stutters too much with a firm grip, lower wire speed, or decrease inductance.

The end of the wire should be positioned just barely above the metal when the trigger is pulled for the cleanest start. This will position the end of the contact tip about 1/2" above the weld. The gun should be in the vertical position, with no more than 5 degrees lean in either side to side direction. Holding the wire too far off from the metal will result in rough starting and too long of wire stick out.

Once the arc has been established, the gun can then either be pushed or pulled in the direction of the weld. In either case, the gun nozzle should be positioned directly over the weld without angling the wire to one side or the other of the

## MIG OPERATION AND THEORY

weld as already mentioned. The gun should have no more than 15 degrees lean pointed into (push) or pointed away from (pull) the direction of travel. In most cases a push motion is desired. However, a lot of texts offer conflicting information on whether to push or to pull the gun. In reality, both are correct if used correctly and with each having particular strength and weakness. Either one done with too much gun angle will result in undesirable results. Most modern trained people who are well versed in MIG quickly develop a sense of when to push and when to pull the gun. Even for novices, a sense of when to push and pull the gun comes quickly with a little practice. Pushing can result in shallower penetration but the molten puddle is easier to see and the arc sits easily on the leading edge. It will usually leave a aesthetically pleasing bead. However, be careful to prevent the gun from leaning toward or away from the direction of travel too much as spatter will increase and shielding gas flow may become turbulent, creating porosity in the weld. Pulling will result in deeper penetration, but can result in a narrow bead without much side fusion. It also can leave an undesirable humped appearance if not done correctly or if travel is too slow. *Whenever MIG welding with Aluminum, whether with the standard MIG gun or the Spool gun ALWAYS push the gun. If using Flux Core, a dragging motion is almost always recommended.*

Weaving (oscillating the torch from side to side in one pattern or the other), particularly a MIG bead, is a topic of controversy as much as whether to push or pull the MIG gun. Stringer beads are often best for novice welders. Stringers are simply straight beads that move forward with little or no side to side travel or oscillation. These will offer the soundest welds for a beginner. Stringer welds leave little or no room for contaminants to enter the weld and are the fastest to produce without creating an opportunity for cold lap. Moving too quickly however with a stringer can create undercut which will weaken the weld. The best policy is to move a slow steady speed, making sure the sides of the weld are filled. If undercut is present, it is either from too much voltage or moving before the wire has time to fill the area the

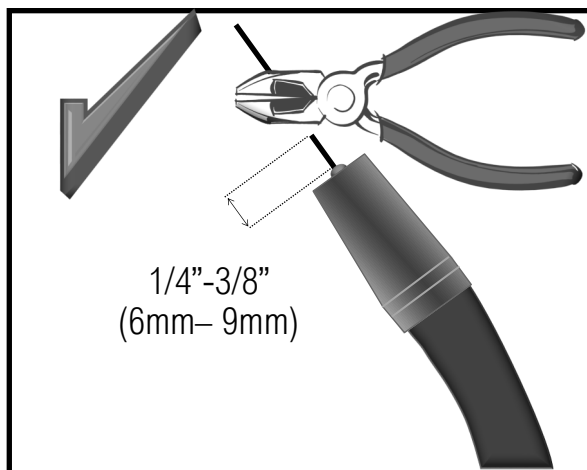

arc has melted.

Think of weaving as a method of “sewing” the metal together. If weaving is of interest to you, start with the basic weave pattern. Simple weaves using one variation or the other of a cursive “e” motion are best to begin with. Other weave patterns can be used of course. C’s, V’s, U’s, Triangles and many more weave patterns can be used depending upon the application. Weaves are employed for a number of reasons. Weaves are often considered to have a more pleasing appearance and can help bridge gaps where fit up is a problem. A weave is also frequently used to manage heat build up. For example: when welding vertically weaves are almost always used to prevent the molten metal from sagging due to the force of gravity. The major drawback of weaving is that it introduces a greater possibility of getting inclusions and other forms of contamination in the weld. Properly done weaving is a valuable tool, but it must be practiced before employing it in any structural or critical application.

**Metal Cleaning.**

MIG welding requires a well prepped surface to obtain a sound weld. The removal of paint, rust mill scale, or other contaminate such as grease should be done before welding. Stick welding is more forgiving of rust and mill scale, but when MIG welding, contaminants will result in porosity and inclusions in the weld, weakening it. A grinder will usually prep the metal sufficiently to remove oxidation and paint. However, to remove grease a degreaser such as acetone should be used. Do not use any degreaser such a brake cleaner with chlorinated solvents or death or serious injury may occur!

A MIG wire such as ER70S-6 or ER70S-2 includes a sufficient level of deoxidizers such as silicone and copper that are formulated to allow it to handle minor to moderate amounts of rust and mill scale. These deoxidizers will float out most moderate amounts of contaminants out of the weld and will appear in the usual form of glassy like deposits on top of the cooled metal. They are easily brushed off before starting the next pass. They should not be welded over. Any pinholes that appear are a result of trapped gas in the weld and should be ground out before the next pass. It should be noted that some MIG wires such as ER70S-3 have low levels of deoxidizers and must be thoroughly cleaned and ground before welding.









**Multiple Pass Welds.**

One of the common misunderstandings that people have when beginning to MIG weld is about weld capability. Many mistakenly believe that if the welder has the amperage output to weld something in a single pass, then it is fine to weld it that way. In fact marketing often drives this kind of thought in comparisons and minimum/maximum statements. However, this is a primary way to introduce cold lap and incomplete fusion to the weld. *As a best practice, single pass*

## MIG OPERATION AND THEORY

*welds should not exceed 1/4" even with the heaviest wire the welder is capable of handling.* A thick pass may also begin to cool before contaminants and gas pockets have the time to float out to the surface. It's far better to make multiple smaller passes to complete a plate weld for a higher quality result. For best results, this requires that most joints 1/4" and over be prepared with a grinder to accept multiple weld passes. The weldment edges should be ground to form a V, U or J shaped groove to create a recess where the welds can be welded one on top of another. Though thicker welds are technically possible, when welding with .035" wire and under, create a bead no thicker than 3/16" in a single pass, no more than 1/8" with .030" wire, and with .025" wire and smaller no more than 3/32 for best results. This will help maintain proper fluidity of the weld and prevent gas from being trapped in the weld and give time for any minor contaminants to float out of the weld. It will also help to maintain reasonable forward travel speeds. Too slow of travel speeds will create excess build up and can tend to create cold lap at the weld toes resulting in poor tie in. One issue created with a weaving technique even if the metal deposited is the correct thickness is that it can slow the forward progress down. If weaving is too wide, one side of the puddle will cool and oxidize before the torch is brought back across to that side. This is a point where porosity and inclusions can be introduced.

**MIG OPERATION AND THEORY**

<p><b>V-GROOVE (60-80°)</b></p> 	<p><b>DOUBLE V-GROOVE</b></p> 	<p>Besides a butt joint and lap joint which are often used for thinner metal gauges, consider using one of these groove joints for best welding results. When grinding or cutting the bevels, especially with a single V-groove, it may be beneficial to leave a small land with a gap between the joint to achieve full penetration. In this case a temporary backer plate can be used to support the bottom of the weld to create the root pass. The root weld will weld the backer to the main plate. This backer can later be ground or cut off. However, in many cases a plain open root can be used as a backer plate adds to the time and labor involved. A knife edge is also acceptable so long as the joint is fully penetrated when the weld is completed. Open root gaps without a backer can range from 1/16" to 1/8" depending upon wire diameter and application.</p>
<p><b>U-GROOVE</b></p> 	<p><b>DOUBLE U-GROOVE</b></p> 	
<p><b>BEVEL GROOVE</b></p> 	<p><b>DOUBLE BEVEL GROOVE</b></p> 	
<p><b>J-GROOVE</b></p> 	<p><b>DOUBLE J-GROOVE</b></p> 	
<p><b>JOINT PREPARATION</b></p>		

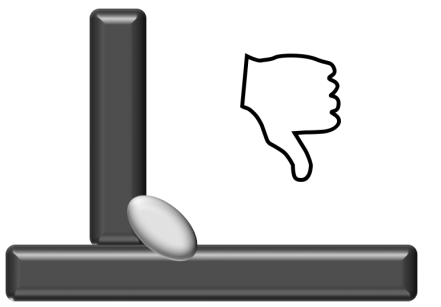
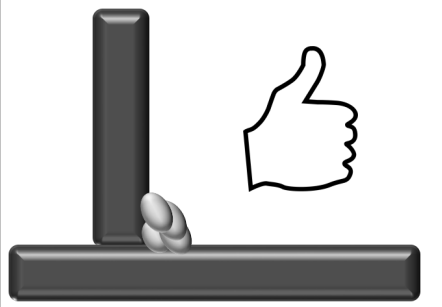
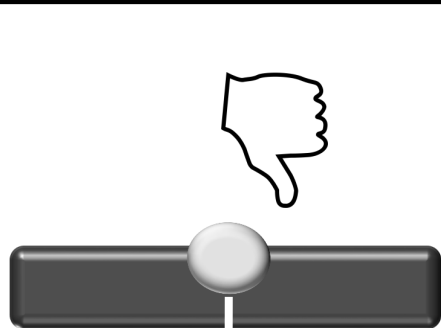
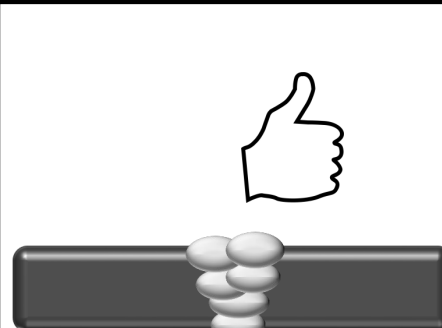

 <p><b>≥ 1/4" Fillet</b></p>	 <p><b>≥ 1/4" Fillet</b></p>
 <p><b>≥ 1/4" Butt</b></p>	 <p><b>≥ 1/4" V Joint</b></p>

**NOTICE:**

When welding material 1/4" and over be careful about trying to put too much metal down in a single pass. Use multiple passes to complete the weld along with any necessary joint preparation especially with wires of smaller diameter. As metal thickness goes up so does the number of required passes. Depending upon the wire diameter and power settings used, a 1/4" joint may only require 1 or 2 passes, but a 3/8" joint in plate metal or pipe will require not only beveling but 4 to 6 overlapping weld passes including a cap and root pass.

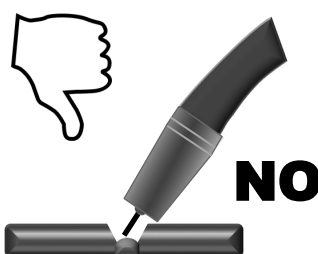
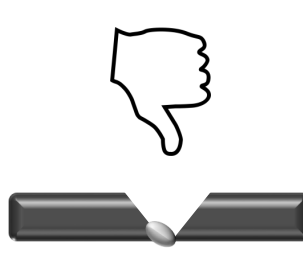
MIG OPERATION AND THEORY

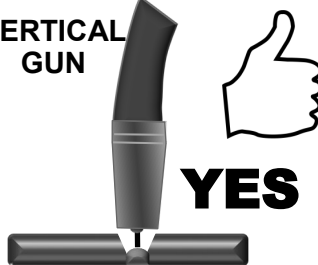
	<p><b>Problem:</b> Gun is not being held vertical from side to side. Wire is not being directed to the center of the puddle. This concentrates heat on one side of the joint and results in poor fusion on the neglected side. It also can create more buildup on one side of the joint than the other.</p> <p><b>Correction:</b> Hold the gun so that the angle of the neck stands perpendicular from side to side.</p>	
---	--	---

<p><b>VERTICAL GUN</b></p> 	<p><b>Correct Technique:</b> The gun is held in a near vertical position. A variance of 5 degrees or less is acceptable from side to side. The purpose is to prevent the arc from being concentrated on one side of the weld joint or the other. This balances the heat on both sides of the joint and keeps the bead centered. Don't confuse this with push or pull angle in the travel direction.</p>	
--	---	---

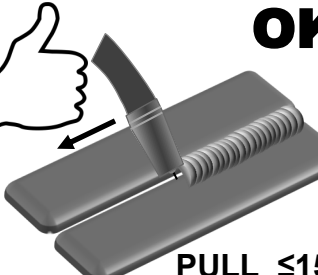
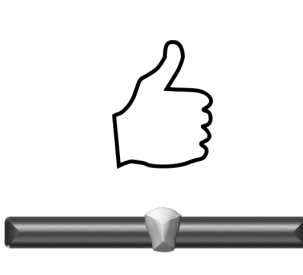
 <p><b>PULL <math>\leq 15^\circ</math></b></p>	<p><b>Correct Technique:</b> The gun is angled toward the back of the weld when traveling forward. This angle should not exceed 15 degrees. This provides a narrower but more deeply penetrating weld. Use this method when Flux Core wire is being used. Use this method where the unit may be reaching its maximum welding capacity. Not for use with Aluminum wire.</p>	
---	--	---

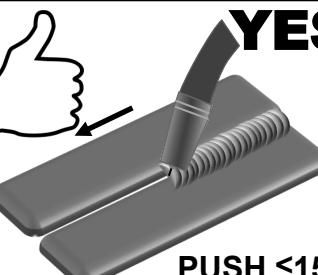
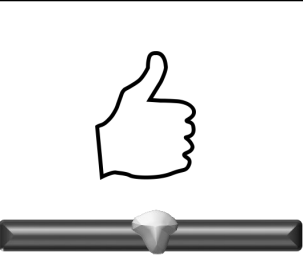
 <p><b>PUSH <math>\leq 15^\circ</math></b></p>	<p><b>Correct Technique:</b> The gun can be angled toward the front of the weld when traveling forward. This angle should not exceed 15 degrees. This provides a wider and generally more pleasing weld. However it is shallower penetrating. This method typically allows a much better view of the arc. Use for most types of welding unless deeper penetration must be achieved.</p>	
---	---	---

## MIG OPERATION AND THEORY

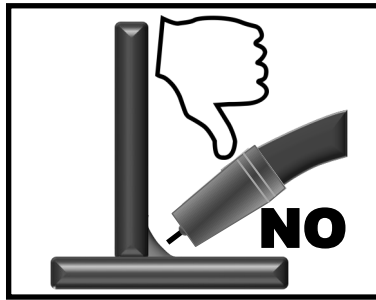

**Characteristics:** Concave weld, poor filling, possible undercutting resulting in weak weld.

**Possible Causes:** Voltage too high, not enough wire speed, too short of wire stick out, wrong gun angle.

**Remedy:** Decrease voltage, use push motion, increase wire speed.

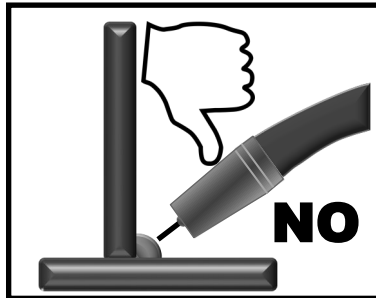

**Characteristics:** Small Convex weld possibly with bulging sides/cold lap and/or an inconsistent arc.

**Possible Causes:** Not enough Voltage or Amperage. If weld is ropy and thin without bulging at the toes, travel speed is too fast or using a pull technique.

**Remedy:** Increase voltage and amperage, slow down to fill joint more. Use push technique.

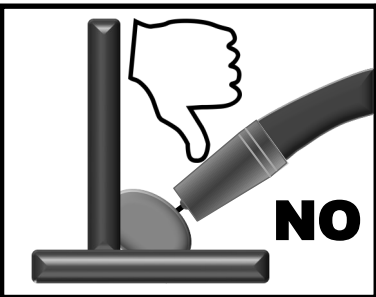

**Characteristics:** Large convex weld with bulging at toes, weld legs exceed thickness of the metal being welded.

**Possible Causes:** Not enough voltage, too much wire speed, overfilling due to too slow of forward travel speed, and/or poor weaving technique.

**Remedy:** Increase voltage, increase forward travel speed, reduce weaving width.

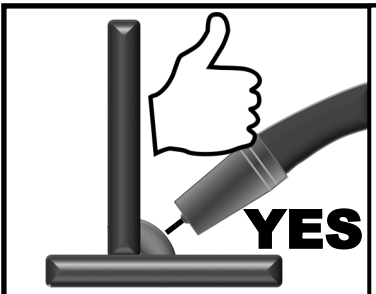

**Proper Weld Characteristics:** Weld is slightly convex, weld legs (vertical and horizontal width of weld) are equal in length and match the thickness of the metal being welded. No traces of undercutting, Proper tie in of the weld at the toes with no cold lap. Weld is not overfilled or under-filled with no significant amounts of spatter, soot or contaminates around weld. Weld is not oxidized and is bright.

## MIG OPERATION AND THEORY

*Special Notes Concerning Operation.*

1. **Shielding Gas Selection for MIG and TIG.** While welding aluminum with the Spool gun or MIG gun you must use 100% Argon. You cannot use a mix as you would with steel or stainless. For Steel or Stainless, there are a variety of gases that are used. The type of gas used with Steel or Stainless depends upon whether you are using short-circuit transfer, or spray transfer. In general, the best general gases mixes for welding with Steel are gas mixes that are less than 80% Argon with the balance CO<sub>2</sub>, or CO<sub>2</sub> and O<sub>2</sub>. A Common mix, usually referred to as a C25 mix, (75% Argon, and 25% CO<sub>2</sub>) is typically the most economical of the steel gas mixes. 100% CO<sub>2</sub> is permissible as well, and is the most economical option for steel welding. However, more spatter and less aesthetic welds will result, requiring more labor during cleanup. For Spray-Transfer, or, gas mixes with greater than 80% Argon content is recommended. Common spray transfer gases for steel are 90/10 Ar/CO<sub>2</sub>, 95/5 Ar/CO<sub>2</sub>, 98/2, Ar/CO<sub>2</sub> or 98/2 Ar/CO<sub>2</sub>. Some welding suppliers also suggest Trimixes of Ar/CO<sub>2</sub>/O<sub>2</sub> for spray transfer or pulse spray transfer welding of Steel. For Stainless, there are several recommendations for welding with stainless whether in Short-circuit transfer. But there is mixed consensus on the best gas for use for short-circuit, Pulsed-spray transfer and Axial-Spray transfer. Stainless develops a more sluggish puddle and wet is not as smooth and easy flowing as steel or aluminum. 98/2 Ar/CO<sub>2</sub>, or 98/2 Ar O<sub>2</sub> is often recommended for spray-transfer welding when economy is needed. In fact other less Argon rich blends are sometimes recommended, and it is possible. But when more CO<sub>2</sub> is added, the rust resistance of stainless goes down due to the added carbon content. Ideally, there are several Tri-gas mixes out there that are well suited to welding stainless. These include the addition of Helium to the mix as either the primary or secondary component of the mix. The Helium tends to help improve wet-in and fluidity of the puddle, but a higher voltage may be needed to weld if the Helium content is too high. It is also much more expensive.

Welds made with Tri-gas mixes tend to hold their rust resistance better. But to reduce the heat that is put into the weld, and reduce warping, there are stainless tri-gas mixes on the market that have a content of approximately 35% or lower Helium. These still are great for preserving rust resistance of the stainless alloys. Wet-in is still excellent and cost is much lower than higher Helium content blends. While welding in any of the TIG modes you must also weld use 100% Argon for any metal type. In some cases, blends of Ar/He may be used for TIG for welding thicker metal thicknesses, but the cost to do so is quite high as He/Argon mixes are expensive by comparison. Do not use more than 25% He in any mix or starting the arc and maintaining a stable arc will be difficult.

2. **MIG Welding Aluminum.** While welding aluminum with the Spool gun or MIG gun you must use the next size up tip or a special oversize tip for the wire because the heat will cause the aluminum wire to swell and it will either drag or seize in the tip, due to the dissimilar expansion rates of the copper tip and aluminum wire. If you are suffering burn backs while welding Aluminum (and in some cases stainless), change to a larger tip, and reduce burn back time. While welding aluminum with the MIG process, best results are achieved by using a dedicated stainless steel brush to remove the oxide layer and using acetone or aluminum cleaner before welding to remove any residues. Even though aluminum may appear shiny and clean, it still has an oxide layer and a thin layer of oil left over from the manufacturing process. Some soot will appear in most Aluminum MIG welds but if a lot is noticed, you have either contaminated metal, or insufficient gas flow. You can also induce turbulence by having too much of a torch angle. Start with a 90 degree angle and then lean the gun slightly (about 15 degrees) to the "push" position. Welding aluminum is not typically a short circuit process. It is a spray transfer process or a Pulsed-Spray process. Spray and Pulsed-Spray transfer are processes that are used to weld many metals, but in Aluminum it must be used to obtain the most sound quality welds.

## MIG OPERATION AND THEORY

3. **Spool Gun Selection.** When using the optional spool gun, the wire speed control is controlled on the spool gun. You must purchase a MTS version of the spool gun to operate correctly. You may purchase a compatible spool gun directly from Everlast for your unit. For the best match-up, we recommend the Parker DSP-360.
4. **Flux-Core Operation.** Flux-Core welding requires the use of serrated drive rollers. These grip the wire and feed it correctly at a steady speed. Flux-Core drive rolls are available for purchase as an optional item. Full time use of Flux-Core filler wire will require the purchase of a flux-core specific gun. Everlast does not supply this type of gun, but many after-market Gun suppliers can supply a Flux -core gun with a Euro-connect fitting and will work. Part-time or occasional Flux-core use with the standard MIG gun is acceptable as long as the nozzle is kept free of spatter.
5. **Generator Use.** When running this unit on a generator, the manufacturer of the generator must certify it as a having "Clean Power" output. This means the unit produces a truer sine wave and is not a modified sine wave generator and is largely free from harmonic distortion. A clean power generator is usually listed as such, but the manufacturer of the generator should be able to clarify the clean power status of the generator through the technical department of the generator manufacturer. Everlast does not keep a list of approved generators nor does it make endorsements of generators that are listed as clean power output. The generator power requirement for this unit is a surge capacity of 12,000 watts.
6. **MIG/TIG 2T/4T settings for the sequencer.** For TIG, the 2T/4T feature allows operation without a foot pedal. In many circumstances, a foot pedal is not practical for use. So, the 2T/4T function has been created to allow sequencer programming of the welder to simulate the activities of the foot pedal while providing more accurate control. In TIG mode you are controlling Pre-Flow, Post-Flow, Start/End Amps, Up and Downslope of the Amps with the sequencer. For MIG, the 2T/4T feature allows control of the sequencer programming giving the user the choice of operation styles. This allows the unit to be operated with-

out keeping the trigger pressed. This allows the user to improve productivity while reducing fatigue. In some circumstances, it allows the unit to be used with some auto-welding machines. When used in MIG mode, you are controlling the Pre-flow, Post-Flow, Start/End WFS, Up and downslope of the Volts with the sequencer. The "T" refers to the number of "travels" of the remote switch required to operate the programming of the sequencer. 2T is essentially a "press and hold" operation and all programming is cycled automatically. Releasing the switch begins the final stage of programming. 4T operates differently in the fact that each touch activates a different stage of the programming, allowing for greater control. In 4T mode, while welding at full selected value (MIG: WFS, TIG: Amps), no finger contact with the switch is required. Following the graphic lines below, you can visually trace the activity and function of each part of the welding cycle. In either 2T or 4T operation the programming can be reset to "upslope" before reaching the end amp stage by pressing the switch once more. See the graphics below for further explanation. The up and down arrows indicate the switch travel direction.

2T Torch Operation Effect on Weld Cycle.

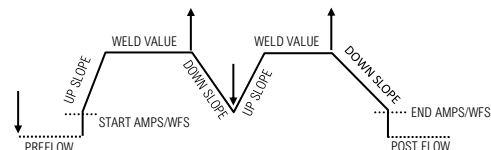

↑ = UP ON SWITCH  
↓ = DOWN ON SWITCH

4T Torch Operation Effect on Weld Cycle.

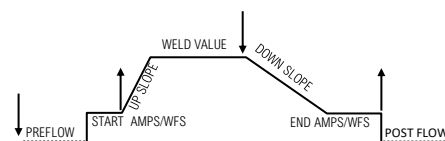



## STICK OPERATION AND THEORY

## STICK ARC STARTING METHODS

1. Make sure the unit is turned on and the boot cycle has finished.
2. Select the Stick Process on the Selector.
3. Make sure the electrode holder is in the Positive connector and the work clamp is in the negative connector.
4. Select the Amp level desired. No voltage adjustment is available. Select Hot Start Time and Hot Start Amps % (Intensity) to improve starting reliability. Use higher amounts of Hot Start %, over 50% with difficult to strike rods, or rods that aren't fresh or out of a sealed metal can.
5. Use the arc force control to select the desired arc characteristics, creating the desired arc characteristic and amp response needed to maintain the arc. Cellulose electrodes may not have the same arc force behavior as other welding electrodes, but each brand and size will weld a little differently. Typically rods such as the E6010 will require a setting 60-80% for best results. The arc force control setting will vary from person to person as well, with different rod angles, positions, and arc lengths all factoring into the arc force control performance. *If you are new to using an inverter welder, there are some aspects that will seem different. One of the main ones is that the arc is better controlled in most situations by "pushing in" when the arc seems to get weak or unstable and the arc force will kick in as the voltage drops. Holding too long of an arc will signal the inverter to shut down and to terminate welding output.* This threshold is shorter than most transformers, and an extremely long arc cannot be maintained. However, with a little practice, the arc will be easy to manage with some adaptation in technique.
6. Strike the arc with either the tapping method or the match strike method. Beginners usually find that the match strike method typically yields the best results.

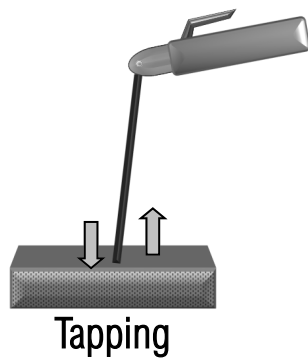

## HELPFUL HINT:

Pay particular attention to the Arc Force setting as it affects the aggressiveness of the arc and the amp response. Set the Arc force to approximately 30-50% and readjust it from that point to find the optimum setting. Adjust in increments of 5% up or down from there to obtain the best results. Usually, an increase in the arc force for cellulose based flux welding rods is helpful. Lowering the Arc force setting is generally desirable for rods iron powder/Titania based flux. Too much arc force will create overheating of the welding rod, and even cause them to flame up. Too little can lead to sticking and arc snuffing. Use the Hot Start features to improve arc starting and cut down on failed arc strikes. Hot Start Amps refers to the % over the set amps that the amps will be boosted during arc striking until the arc is established. Hot Start Intensity controls the amount of time that the Hot Start stays engaged after the arc is struck. Start by setting Hot Start to somewhere between 30% and 50% and set hot start time to .5-1 seconds. Adjust in increments of 5% up or down to obtain best starting results.

When welding, the weld will be slower than MIG speed. One of the most common mistakes for users transitioning from MIG to Stick welding is the travel speed. Allow the metal to fill the puddle as the rod travels forward. Be sure to try to separate the difference between the slag and the molten pool of metal. The slag will coalesce behind the puddle if travel and rod angle is correct. Do not let the slag travel in front of the puddle. Keep the top of the rod inclined to the direction of travel around 10-20 degrees while welding in the flat position (Electrode holder should be in front and inline of the puddle). To begin, simply start the arc, and then drag the rod slowly and carefully along the metal, allowing the rod flux to provide a standoff between the metal filler and the puddle. Be sure to keep feeding the rod steadily downward into the puddle as the rod melts. In the case of E6011, a slight stepping motion in front of the puddle about 1/8"-1/4" in front of the puddle can be used as a key hole opens up in the weld joint, ahead of the puddle. This is also called "whipping" the rod. Do not flip the end of the rod away from the puddle in a arc motion or the arc may terminate while using E6011 or similar cellulosic rods. When experience is gained, numerous manipulation methods may be used with rods such as E7018, 7014, 6013, and 7024. Weave the rod no more than 2.5 times the width of the welding rod. To begin weaving, weave small, tight patterns similar to C's, cursive E's, V's, or even figure 8's.

## IMPORTANT!

This unit is designed for operation with Cellulosic electrodes such as E6010 and E 6011. However, to use these rods, the Power-Set mode must be engaged, and the correct rod type and size selected. Improved function of all rods can be obtained through the use of the Power-Set function. In manual mode, rods such as E7014 and E7018 work well, but selecting the Power-Set mode can simplify operation and improve performance. 120V operation will reduce the capability of the E6010 setting however since arc force action is limited and hot start action is reduced.

## TIG OPERATION AND THEORY

**General Setup.** The process to set up the welder for the basic TIG mode is much less involved than for basic MIG. TIG voltage is not conventionally adjustable and is a product of the arc length. This is not to say voltage is not important to TIG welding, but it is not something that can be adjusted on the unit. In practical terms, voltage is not a concern to the user as it is self regulating. Amperage however, is adjustable. Setting up Amperage correctly for TIG is different as there is no “sound” to listen for. But for each given thickness of metal, there is an acceptable range of adjustment for TIG. Traditionally, a general rule of thumb for TIG setup is to set approximately 1 amp for every .001” of metal thickness. For modern inverter technology, that may be too many amps in all but the thickest weld material, particularly for a DC inverter TIG welder such as this one. In many cases, you will only need to use 75% to 80% of that amperage. But if you are setting up the unit to use a foot pedal, use the rule of thumb to begin with as you can always back off the amperage as you are welding by letting up some on the foot pedal. Much of the information in the “Basic MIG Operation” guide in this manual is useful and applicable for TIG welding. Pay particular attention to the subsections about metal cleaning and multiple pass welds. If needed, there are several online TIG apps and calculators that you can give you starting points for welding almost any thickness as well as general settings for tungsten size, and gas flow rates. But more importantly, utilizing the Power-Set mode of this unit will eliminate having to “guess” at proper settings for your application.

Use the information on the following pages to help guide you through arc starting and tungsten preparation.

**Welding.** If you are new to TIG welding, it’s important that you understand that TIG welding is much slower than MIG or Stick welding. It requires patience and steady practice to become proficient at TIG welding. However, most people can achieve some level of proficiency at TIG welding if they are patient, and are willing to analyze and adjust the way they are welding. To start welding, set the amps desired for the metal thickness you are about to weld. Before striking the arc, make sure the shielding gas is on, and properly

set. Also adjust your Tungsten stick-out to about 1/8” and gas flow rate to approximately 16-20 CFH to begin. Then follow the TIG arc starting methods on found later in the manual. Once the arc is started, keep a loose but sure grip on the TIG torch to prevent cramping. An underhand hold is good, similar to the way a pencil is held. A foregrip may be used as well, but offers less fine control at the beginning and requires more propping to keep the torch steady. Practice running slowly without filler metal first. Keep the torch head inclined away from the direction of travel, so the Tungsten stays just above the puddle, pointed toward the front of the puddle. Move slowly and methodically, gauging your forward movement to make sure it is steady and paced. Imagine a thick coin is able to be placed between the tip of the Tungsten and the weld puddle. As your skill progresses, you will want to add filler wire to your practice. The angle created between the filler rod should be about 90 degrees. In between the filler rod and the torch, your head should be placed so that you can clearly see the arc. Feed the filler rod into the front edge of the puddle, being careful not to place the filler on top of the Tungsten, or touch it in any way. If you dip the tungsten into the filler rod or into the puddle, you must stop and regrind it or the arc will become unstable. Feed the filler in regular, timed dips as the puddle forms. If you need, count out loud as you time your dips until you can do it without thinking. As you proceed to dip your rod into the edge of the puddle, keep the rod close to the puddle, within the gas cone. If the filler metal starts to melt before you dip, you have it too close, or you have the rod inclined too much so that heat is being directed too far in front of the puddle. As you add the filler, be sure to pause momentarily with the forward travel of the torch. If desired, a tiny back step motion may be used to improve weld appearance. There are other ways to add filler and to create a sound weld. You can keep the filler wire in the puddle, with the rod laying in a flatter profile and weld. As the torch moves forward and the rod melts, the filler can be slid, with gentle pressure, into the puddle as needed to fill the weld. This is known as the Lay-Wire technique. Another method of welding has more to do with torch manipulation than it does filler addition, is called walking the cup. The cup is rested on the metal while the torch head is os-

## TIG OPERATION AND THEORY

cillated in a figure 8 pattern. This will require a forearm grip typically, and a good bit of motion of your forearm to accomplish. The filler metal should be moved from side to side to provide an evenly filled puddle under the Tungsten. This method requires much practice and effort, but yields beautiful welds when performed correctly. **If you cannot see the puddle or your helmet flashes (auto darkening types), you need to change your settings or obtain a welding helmet rated for 5 amp TIG use. Set delay to long and sensitivity to maximum (or the lowest Amp setting).** Practice feeding the filler wire without actually welding. Manipulating the wire takes practice and concentration at first. The wire should be held so that a flicking motion of two fingers and the thumb can propel the rod forward into the puddle without losing grip on the filler rod. The rod should rest on the two fingers furthest from the thumb, while the index and middle finger grasp the rod with the thumb propelling it forward. Other rod manipulation variations may be used, but the key is to develop a comfortable, natural movement that is regular and consistent. If feeding difficulty is encountered, there are some feeding devices that reduce the effort to feed the filler wire and smooth out the feeding process. Do not let feeding the filler wire hold up the learning process. There are numerous accounts of welders making home-made jigs or devices that help feed the TIG rod smoothly. Make sure you have gloves that offer protection without compromising dexterity. With a proper fitting TIG glove, you should be still able to pick the filler wire up from the table top with your fingers.

There are a lot of hurdles to becoming a proficient TIG welder. But if you will practice when you are not tired, and when you are comfortable in your surroundings, you will generally obtain better results than if you would if you are too tired, or over-heated.

## TIG OPERATION AND THEORY

**TIG Pulse.** The TIG pulse creates two amp values, a high and a low value that cycle back and forth between each other while welding. The upper amperage is called the “TIG Pulse Amps” (sometimes referred to as “Peak” current.) The lower amperage is called “TIG Pulse Base Amps “ (sometimes called “background” or “base” current). This creates a situation where penetration can be achieved without overheating the metal, particularly on metals that are prone to structural deterioration or burn through. In effect you are creating an average of amps. This welder features three adjustable parameters concerning the TIG pulse:

1. **Base Pulse Amps.** Base Amps is the low Amperage value of the pulse. When you adjust the base Amps in pulse mode, you are actually setting a ratio of base Amps to peak welding Amps. Base amps are expressed as a percentage of Peak welding Amps. So, when you set base amps, you are only setting it as a percentage, not the actual Amps. As you increase Peak welding Amperage through the use of the foot pedal, or the panel control, the pulse will maintain the same ratio of Base to Peak welding Amps, raising the base Amps automatically. To illustrate: Adjust the Peak (main welding) Amps, to 100. Set the base Amps to 50%. This will yield a 50 Amp value for the base Amps. The foot pedal controls both Peak welding Amperage and Base Pulse Amperage simultaneously, using the pre-set ratio.
2. **Pulse Frequency.** Pulse speed or frequency as it is referred to is measured in the standard unit “Hertz.” Simply, it is the number of pulses per second that occur. Pulse frequency controls the arc constriction and also helps with heat management.
3. **Pulse Time On (Balance).** Pulse Balance is the percentage (%) of time that the pulse stays in the TIG (Peak) pulse Amp stage of the cycle. Increasing the Pulse time-on will increase the duration the Peak Amp stage of the cycle which in turn will increase the heat and will increase penetration. Pulse Balance is also known in the industry as duty cycle. For welding purposes the term “Pulse Time On” is used here.

## EXAMPLE 1

Peak Pulse Amps: 100 amps,  
Base Amps: 50%  
Pulse Time On: 50%  
DC Pulse Frequency: 1 Hz

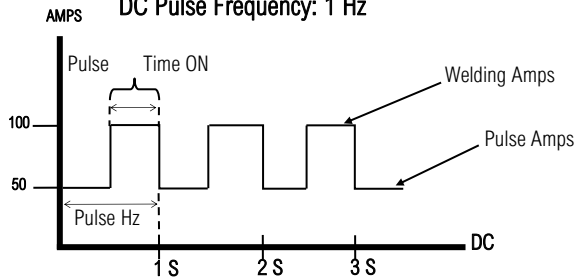

## EXAMPLE 2

Peak Pulse Amps: 100 amps  
Base Amps: 50%  
Pulse Time On : 50%  
DC Pulse Frequency: 25Hz

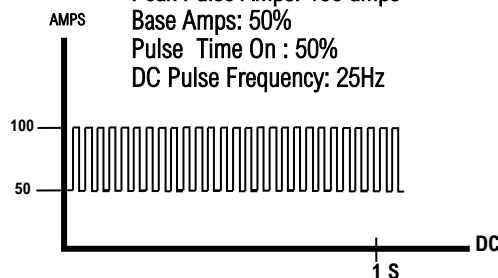

## EXAMPLE 3

Peak Pulse Amps: 100 amps  
Base Amps: 25%  
Pulse Time On: 75%  
DC Pulse Frequency: 3 Hz

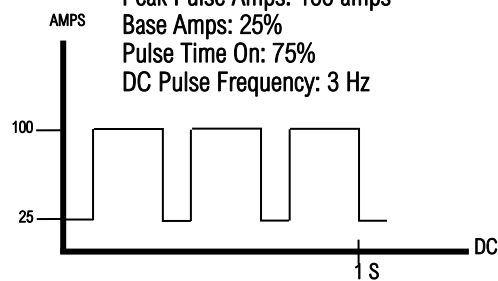

Setting up the pulse is not a process where a fixed adjustment procedure can be assigned or rigidly recommended. Changes to frequency, balance, and time will skew the final result. A slow pulse with a equal 50% pulse time on and somewhere around a 50-75% Pulse Base Amp setting is typically used to help with timing the addition of filler metal to the weld puddle. A higher pulse frequency level that is combined with variations in Pulse Time On and a narrow/wider ratio can be used to prevent burn

## TIG OPERATION AND THEORY

through and speed up welding on thin materials. It can also help maintain a proper bead profile on a thin edge weld or prevent burn through on extremely thin metal. A fast pulse speed will make fine ripples in the weld while a slow pulse speed will give a much more coarse, but visually appealing result. There are limitless ways to adjust the pulse. Regardless of how you choose to adjust the pulse, always keep in mind, that the basic purpose of the pulse is to average the heat input while maintaining penetration and welding speed.

AC Pulse TIG operation is the same. Do not confuse AC cycling between EP and EN as pulse. It is not. You are still adjusting the amperage of the AC pulse, and skewing the balance and changing the frequency similarly to the DC pulse.

**Advanced Pulse.**

The advanced Pulse is designed to be used with Aluminum only. It features an alternating mix of AC and DC- during the pulse cycle. The Peak welding Amp portion of the Pulse is assigned to the AC output. The base Amp portion of the Pulse is assigned to the DC- polarity. The combination of the two allows the AC portion of the pulse to provide the cleaning, while the DC- portion of the pulse can be used to provide the penetration.

The goal of the Advanced pulse is two fold:

1. This provides a way to greatly extend the welding capacity of the unit. By setting the DC- base Amp portion of the Pulse to a high value, penetration can be greatly increased up to 50% over normal maximum welding capacity.
2. When DC- is set to a low value, fine control on thin metals can be achieved with improved bead profile.

Besides the combination of AC and DC-, with the DC- being the base portion of the pulse, Pulse time on and Pulse Frequency serve the same functions as they do in standard pulse. These are adjusted the same. However, due to the purpose of the Advanced pulse, Pulse Frequency is limited to 10 Hz.

It may take practice to master Advanced Pulse, learning when to time dips, on alternating cycles,

but this unique pulse function expands the capability of the unit on both the maximum and minimum ends of output.

**NOTICE:**

Both forms of pulse may be used in conjunction with the Power-Set. However, both forms of pulse must be first set in manual mode before engaging Power-Set mode.

## TIG OPERATION AND THEORY

### AC TIG Operation.

AC TIG operation is a new and unique feature for compact MIG/TIG/Stick multi-process units. With that said, this welder is a well developed machine, with both HF start and AC TIG/AC Pulse TIG features with industrial capability in all processes. To be capable of all processes, there are some equally unique technological challenges to address. Everlast has sought to include everything possible without compromising performance or quality without over complicating the machine. While it is certain that others in the industry will follow Everlast's first to market model, none will likely be as simple and convenient to operate with less points of failure. In order to eliminate the most points of failure possible, we have chosen to include a separate circuit for AC, which outputs directly from the AC part of the inverter to a separate AC terminal (DINSE connector) that is to be used with the work clamp only when in AC TIG or AC Pulse TIG modes. By doing this, we have isolated possible interference from the AC side of the machine with other circuits used for other processes. This has simplified internal structure and reduced the need to compromise performance. But you will always need to make sure that the work clamp is moved over to the AC terminal when you change over to AC TIG. You will not need to move the torch, as it will always stay in the negative terminal. If you do not manually relocate the work clamp to the AC output terminal, you will experience erratic operation, and in the long term, possibly incur damage the internal components.

With the addition AC to the unit, there are a few more items that should be covered in greater detail to help the user to understand exactly what is going on.

**AC Wave Forms.** The wave form control is a useful feature for achieving a desired type of arc performance in AC mode. There are 4 wave forms to choose from. These are the most commonly found forms, though there are other types of wave forms. The standard, default wave form is the advanced square wave. This wave form is excellent for all types of welding, and offers quick puddle wet-in, and good arc stability. The triangular wave form is useful in situations where a fast freezing puddle is

desired, particularly on thin aluminum. Total heat output is affected regardless of the amperage selected. In the Triangular wave form maximum output will seem colder with less aggressive wet in and colder fusion. Using the triangular wave form at the same amperage of the Advanced Square wave form will demonstrate the stark difference. You should notice a colder puddle with a different bead profile. The soft square wave, offers a buttery arc, with a smooth, easy feel similar to the feel of a standard square wave transformer-based welder. The soft square wave may be preferred by older, more experienced welders, who have spent time on transformer machine welders. The Sine wave is the wave form of older style transformer welders. This provides a soft, but capable arc for those that desire a more traditional behavior from their welder. Heat output and wet-in will seem somewhat muted in comparison to the Advanced Square wave. At the beginning, for all our users, regardless of experience, we suggest that you use the Advanced Square wave until you are familiar with the machine.

**AC Frequency.** The AC frequency only applies to the AC mode. Standard transformer welders typically have a fixed frequency of 60 Hz which is essentially the line input frequency supplied by the power company. But with inverters, the capability of AC frequency adjustment is practically limitless due to the IGBT components that create its own frequency. Frequency adjustment capability is useful to help improve directional control of the arc, and to focus the arc so that a narrower bead profile can be achieved. Also, at higher frequencies, the puddle agitation is greater which improve the breakup of undesirable oxides. All wave forms can be adjusted from 20-200 Hz.

The AC output is formed by rapidly alternating polarity between electrode negative and electrode positive, creating something that resembles a wave when viewed on an oscilloscope. Normally, with standard transformer welders, both standard sine wave and even square wave welders have little or no way to change the ratio of EN to EP, which results in welding with a molten ball at the tip of the tungsten and a less stable arc. Electrode negative (EN) pro-

TIG OPERATION AND THEORY

vides penetration in the TIG welding process. Electrode positive (EP) creates a strong reverse flow of electricity that breaks up the weld-resistant oxidation that covers aluminum and magnesium components.

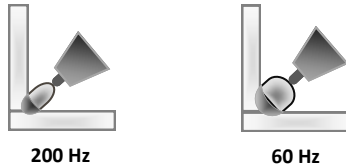

**AC Balance.** The AC output is formed by rapidly alternating polarity between electrode negative and electrode positive, creating something that resembles a wave when viewed on an oscilloscope. Normally, with standard transformer welders, both standard sine wave and even square wave welders have little or no way to change the ratio of EN to EP, which results in welding with a molten ball at the tip of the tungsten and a less stable arc. Electrode negative (EN) provides penetration in the TIG welding process. Electrode positive (EP) creates a strong reverse flow of electricity that breaks up the weld-resistant oxidation that covers aluminum and magnesium components also places a lot of heat on the tungsten. In a “balanced” wave where both EP and EN are equal in time length (50%), penetration is reduced and over-cleaning results in wide etch lines running parallel to the side of the weld. Not all welds conditions will be alike so more cleaning is required at times than others. Similarly, more penetration will be required at times than others. **Ordinarily, about 30-35% electrode positive is considered an ideal amount (65-70% electrode negative).** This means that more heat is put into the work than on the tungsten and a sharper point can be used. Cleaning is still sufficient at that level. Good results can be achieved with about 30% EP or less. The cleaning action is still significant even at these levels. Ideally, the cleaning action should be adjusted until a small amount of frosting can be seen no more than 1/8” distance from the edge of the weld. If a piece of metal is particularly heavily oxidized or dirty, more cleaning action will be required. If too much cleaning action is used, the tungsten will begin to ball and even may start to burn away. If this much cleaning action is truly needed, then

switch to a larger sized tungsten that can handle the increased heating level. Signs of too little cleaning action while welding aluminum are sooty, black or dull looking welds. (In MIG some soot is normal while welding aluminum.) A dedicated stainless brush and suitable aluminum cleaner such as acetone should still be used before welding any type of aluminum to help break up the heaviest oxide layer so less EP is needed and better penetration can be achieved. Even if the aluminum has a mirror like shine, it is still oxidized.

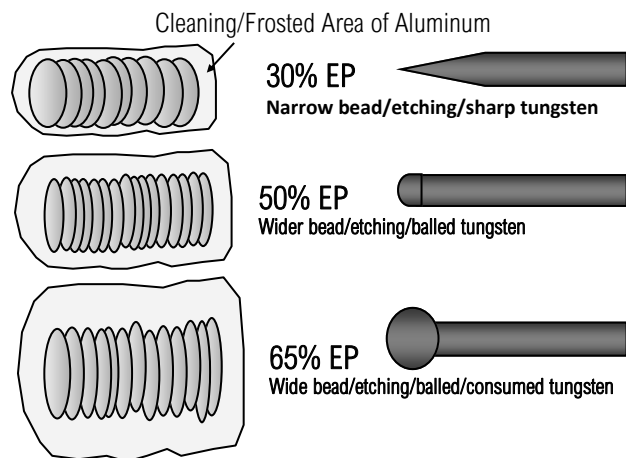

EXAMPLE: AC EP (+) BALANCE

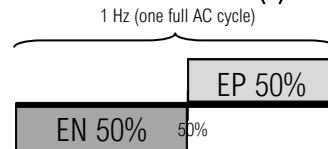

Standard transformer welder balance: 50% EN/EP  
Balling tungsten, light penetration, wide cleaning area.

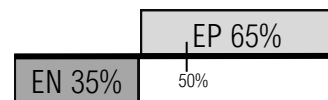

Extreme cleaning setting. 65% EP:  
Shallow penetration, balling tungsten, excessive cleaning area.

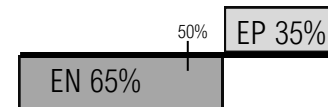

Good penetration setting 35% EP:  
Deeper penetration, sharper tungsten, narrow cleaning area.

## TIG OPERATION AND THEORY

**NOTICE:**

- Due to the rapid switching of the inverter, High Frequency (HF) is not used for anything except starting the arc. The HF TIG only refers to the initial arc start, and can be used for DC as well. In a transformer welder, the HF could be switched to continuous to stabilize the AC arc, but in an inverter, this is not necessary. So, the HF switch refers only to the Start of the arc, and not to AC operation. However to reduce tungsten contamination with aluminum, you should only operate the AC mode with the HF start selected.
- Lift start is recommended only for DC, or for AC when a copper scratch block is used and the arc is transferred. Lift start would be used in areas that are sensitive to electronic interference such as hospitals or computer/CNC equipment.
- The addition of Helium to Argon can increase the welding capacity of the welder and alter the amount of cleaning typically needed. Do not exceed 25% however or arc starts will be difficult and erratic.
- If arc wandering in AC is a problem, reduce cleaning percent, then if it continues, reduce gas flow and then check for drafts or for poor work clamp connection. Also check for highly oxidized or dirty aluminum or a faulty work clamp or connection.
- AC controls only apply to AC operation, and do not affect the settings on DC.
- Too slow of travel speed will increase the etching/cleaning area.
- AC balance on this unit registers as a percent of positive! This is different from some brands which orient there units toward percent negative. The Lightning MTS unit should typically have an AC balance setting of 30%, instead of 70% used with some other brands. In referring to AC balance, it is common to refer to the "amount of cleaning" that is being achieved. Cleaning is a function of Electrode positive and is the reason that the Everlast unit (along with several other brands) refers to AC balance as a percent of full Electrode Positive polarity. **DO NOT TRY TO REVERSE POLARITY OF TIG TORCH TO ACHIEVE THE VALUE OF 70% TO CONTROL THIS UNIT, OR OVERHEATING AND DAMAGE MAY OCCUR.**
- Do not ball Tungsten. Using a sharp or slightly blunted tapered tip offers the best arc stability and welding performance. As you weld, the point will gradually fade into a "bullet" or "dome" shape, without a ball. If you get a ball on your tungsten, you are either 1) Using too much amperage for the Tungsten, 2) Using too high of an AC balance setting, 3) Using the wrong polarity for the torch (TIG torch is always negative, even in AC). 4) Using a gas mix with CO2 (Use pure argon only) or 5) Operating your unit too close to the weld area and the 4 fan cooling system is blowing the shielding gas off the weld. Move the welder at least 8 feet from the work area if possible.
- The AC port is to be used only with the work-clamp, only in AC (Aluminum) TIG. Do not forget to change the work clamp from the DC+ to the AC port, when welding AC, or irregular operation will occur, with high potential for machine damage.



## TIG ARC STARTING

## LIFT START OPERATION

**NOTICE:** When using the TIG lift start function, the lift start should be performed using a light touch and a quick, seamless motion.

Lift Start is often used anywhere HF use is restricted, particularly in hospitals, or where computers are in close proximity. Steel or Stainless are good candidates for Lift Start operation. Aluminum is generally not used with Lift Start due to contamination of the Tungsten. However, in restricted areas, the welder may be operated with Lift Start in the AC mode. When using the Lift Start in AC mode, start the arc on a nearby scrap piece of copper, and transfer the arc over to the work piece immediately after the arc is struck.

**To start the arc with Lift Start:**

1. Position the edge of the ceramic cup on the metal. Press and hold the torch switch or press the foot pedal. Wait for the Pre-flow to start. (Make sure pre-flow is set for less than .4 seconds or start will be noticeably delayed.)
2. Quickly rotate cup so that the tungsten comes in brief contact with the metal.
3. After contact with the metal, *immediately* rock the torch back so that the tungsten breaks contact with the metal.
4. An arc should form. As the arc grows, raise the cup up off the metal and slowly rotate the torch into welding position.
5. Leave 1/8" or less gap between the tip of the Tungsten and the metal. Proceed with welding, leaving the torch inclined at a 15° angle.

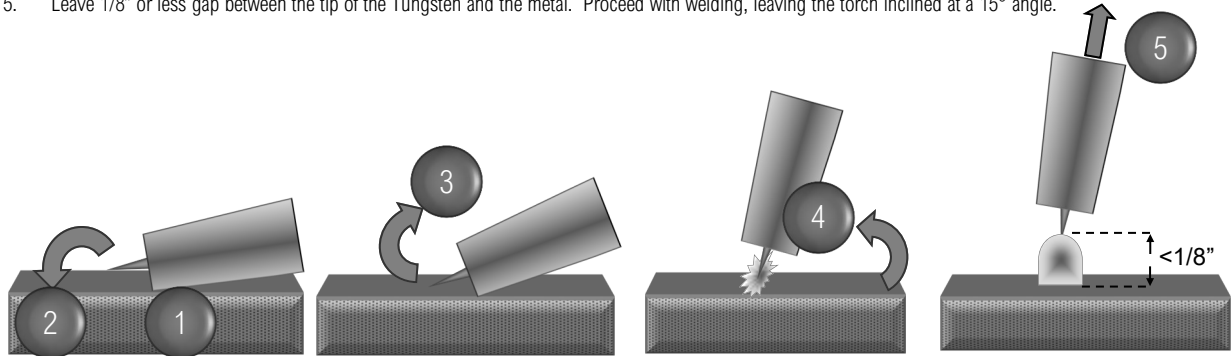

## HIGH FREQUENCY (HF) START OPERATION

**NOTICE:** Low Amp starts require a smaller distance between the workpiece and the tungsten. Smaller diameter tungsten offers the best arc starts at low amps.

HF starts provide the cleanest, and least contaminating type of arc start. No touching of the tungsten is required. HF may be used in AC or DC modes. HF starting is almost always used with AC when welding aluminum. With DC, either Lift Start or HF Start works fine.

**To start the arc with HF:**

1. Position the point of the sharpened tungsten about 1/8" or less above the metal.
2. Press the torch trigger or press the foot pedal to initiate the arc. The HF arc will be initiated. It may appear briefly as a blue spark or small lightning bolt.
3. An arc should form, almost immediately after the pre-flow interval, and the HF arc initiation will be delayed by the amount of pre-flow time used. If arc does not start after the pre-flow interval, and the HF is creating a spark, then check the work clamp contact with the work piece. Move the tungsten closer to the work. Repeat steps 1 and 2.
4. Leave 1/8" or less gap between the tungsten tip and the metal and proceed with welding, leaving the torch inclined at a 15° angle.

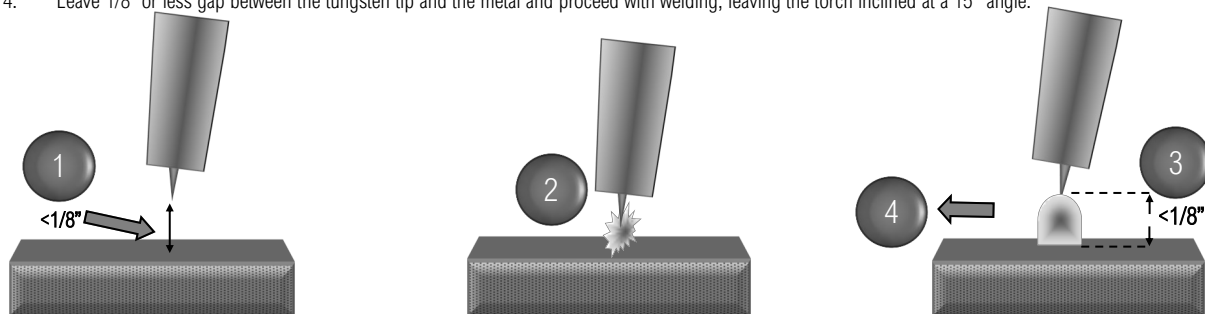

The use of HF does create an opportunity for a mild electrical shock if the Tungsten is contacting skin, or if damp gloves or clothes are being worn while coming into contact with the torch, table or the part that is being welded while the arc is being struck. Try to keep your body from coming into direct contact with the torch, table or parts while welding if this occurs. Use dry gloves to protect the hands.

## TUNGSTEN SELECTION AND SHARPENING

## TUNGSTEN SHARPENING

- Use a dedicated grinding wheel or contamination may result. Do not breath grinding dust! Wear eye protection and gloves.
- Grip the Tungsten firmly.
- Grind the Tungsten perpendicular to the wheel face. Allow tungsten to grind slowly without much pressure.
- Rotate the Tungsten quickly as it is being ground to keep the point even and symmetrical.
- Alternatively you may use a drill to hold the Tungsten. Rotate slowly.

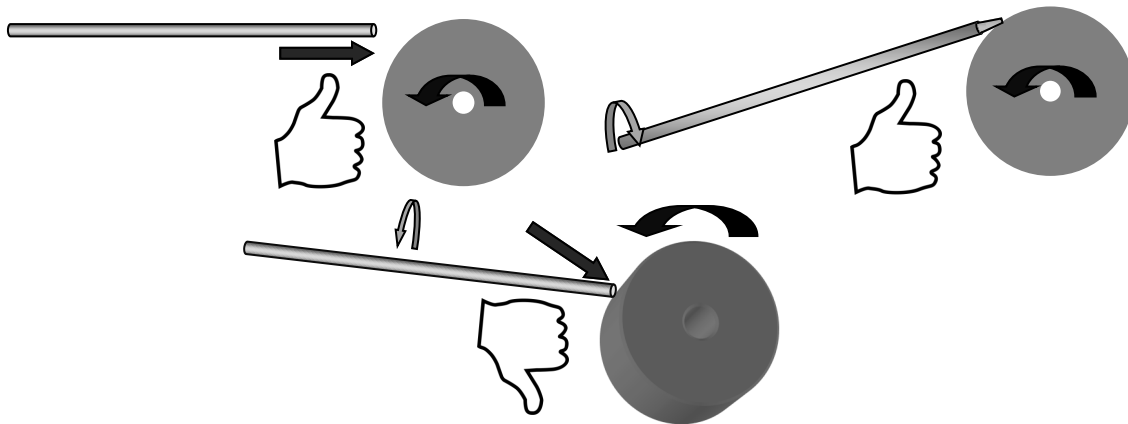

- Do not grind the Tungsten parallel to wheel face or an unstable arc will result.
- Use a point for low amp use to help control arc. Create a slight truncation on the tip for higher amp use for best arc stability. Grind the tip so that it is 2.5- 3 times longer than the tungsten is wide (Diameter).

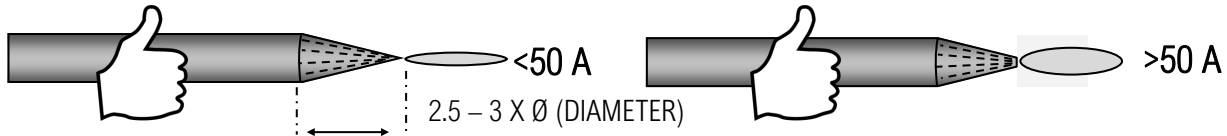

- Do not ball the Tungsten while welding, or an erratic arc will result. Make sure that the grinding marks run parallel to the tip. Concentric marks will also cause an erratic arc.

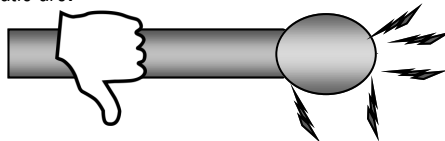

## TUNGSTEN SELECTION

This unit is an inverter based welder. Tungsten types traditionally used in a Transformer machine do not work well and have issues with melting and splitting. Pure Tungsten (Green) should never be used with this unit. Arc quality and stability will suffer, along with over balling of the tungsten will result. Zirconiated (usually brown) has similar issues. Thoriated 2% (Red) Tungsten works well with both AC and DC modes in inverters but tends to split at higher amperages in AC, or forms small nodules on the tip.

Consider the following tungsten types for use in this welder:

- Lanthanated 2% (Blue). Works great for AC or DC. Holds up good to higher inputs. Best for use in Power-Set mode at extreme Amps. Excellent arc starts. 1.5%
- Ceriated 2% (Orange or Gray). Works great for AC or DC. Begins to fade at higher Amps. Great arc starts at low amps.
- Rare Earth or Tri-Mix (Purple). Generally great and holds good point. However some quality issues have been reported with wide range of allowable percentages of rare earths. Primary rare earth component is usually an 1.5% oxidized form of Lanthanum (Lanthanated). Secondary rare earths are usually Zirconia and Ceria oxides ranging from .04 to .08% composition. Some feature Yttrium as a secondary component. Use quality, well known sources.

## IF YOU SEE THIS SCREEN....

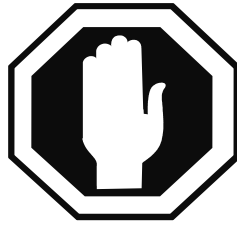
**STOP!****OVER-TEMPERATURE SCREEN**

An Over Temperature means that the Duty Cycle has been exceeded and the unit is over heated. This can be caused by:

- Welding past the 60% rating of the welder.
- Dirty components, failure to service.
- Blocked Air Flow.
- Damaged/Broken Fans

What to do:

- Allow the unit to continue to run. DO NOT TURN OFF!
- Inspect unit for lack of air flow on all sides. Air flows in from back and exhausts from both sides and the front of the welder. Allow 18" of clearance.
- When cool, the unit will reset. Allow 5 extra minutes of additional cooling for a safety factor.
- Try again.
- If unit will not clear the warning after 15 minutes, turn off and back on.
- If unit does not clear after cycling the power switch contact Everlast.



## IF YOU SEE THIS SCREEN....

**STOP!****OVERCURRENT SCREEN**

An over current can be caused by several things.

- Running on undersized extension cord, or too long away from power source.
- Insufficient power source.
- Running on a generator that isn't rated for wattage or for clean power.
- Internal fault has been caused by an external condition
- IGBT or PC board failure.

What to do:

- Turn off unit immediately.
- Investigate cause, remedy if possible.
- Try again.
- If cause cannot be found call Everlast.



## IF YOU SEE THIS SCREEN....

**STOP!****STUCK TRIGGER SCREEN**

A Stuck Trigger Screen can occur for several reasons.

- Primarily, the trigger on the torch has been held for too long without starting an arc (more than 3 seconds) and is caused by the following.
- The trigger has broken, stuck or torch contacts have been accidentally bridged.
- The foot pedal is stuck down, or foot switch is damaged.
- Point gap is dirty or incorrect.
- No or bad work clamp connection.
- Wrong polarity (arc not starting easily and balling tungsten)
- No gas flow/wrong or bad gas preventing arc from starting.
- Broken switch or circuit.

What to do:

- Let go of torch switch or foot pedal. Do not trigger torch or foot pedal and keep button held down for any reason other than starting the arc. For adjusting gas flow, set post flow to maximum setting and then only tap the trigger or the foot pedal to start post flow cycle .
- Investigate cause, remedy if possible. Check work clamp connection, proper function of switch, Gas flow/type, polarity, foot pedal and torch switch operation.
- Try again.
- If cause cannot be found reset unit by cycling power switch.
- If warning does not clear, call Everlast.

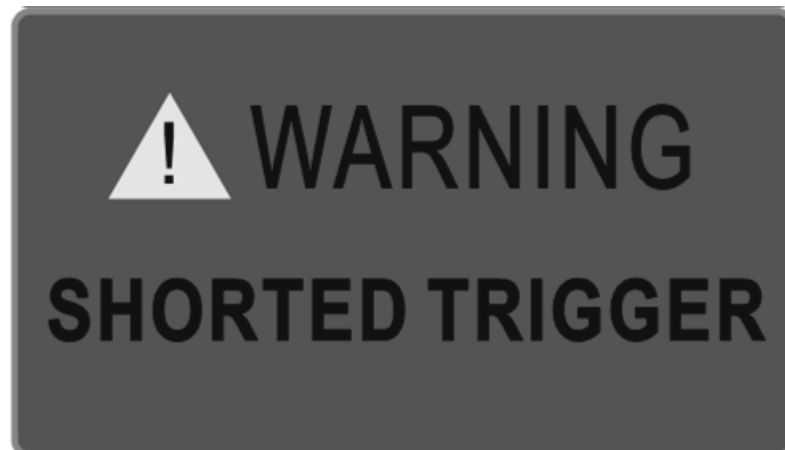

## Section 4

## Trouble Shooting

NO.	Trouble	Possible Cause	Solution	
1	Unit is switched on, but the power light isn't on	Switch damaged.	Replace.	
		Unit Fuse damaged.	Replace.	
		Power breaker tripped.	Reset.	
2	After welding machine is overheating and the fan does not work	Fan damaged.	Check fan housing and fan. Replace if necessary.	
		Fan power connector is loose.	Tighten wires, check for dislodged connectors.	
3	When torch switch is pressed, no gas flows	No gas in the gas cylinder.	Replace.	
		Gas pipe leaks gas.	Resolve .	
		Gas solenoid valve damaged.	Check and clean/replace.	
		Torch switch damaged.	Repair or Replace.	
4	Wire-reeler does not work	Wire reel does not turn	Motor damaged/Fuse blown.	Check and Replace.
		Wire reel turns	Control circuit damaged.	Check the board.
	Wire reel turns	The tensioner is loose or wire slips on rollers. Wrong size drive roll. Wire is not mated in drive groove.	Increase tension. Check for proper drive roll size/type. Make sure wire is in groove not riding on top of the drive roller shoulder.	
		The drive roller doesn't fit the diameter of weld wire.	Change roller or wire size to match.	
		Wire Spool is damaged.	Change out wire spool.	
5	No arc, or no output voltage	Gun liner is jammed.	Repair or change it, clear wire from liner/clean liner with compressed air.	
		Contact Tip is jammed because of slag or burn back.	Clean or replace. If with Aluminum, increase tip size to next size.	
6	Welding stops and warning light is on, Wire continues feeding but no arc is present.	Work clamp engaged in wrong connector.	Change polarity.	
		Control circuit damaged.	Check the circuit.	
7	Welding Voltage/Current is uncontrollable	Self-protection has engaged.	Check over-voltage, over-current, over-temperature, lower-voltage and over-temperature. Allow unit to cool if over heated. If an OC, use a shorter wire stick out or smaller diameter wire or reduce power settings with large diameter wires. Check power plug for problems. If easily tripped the Resistor value too low. (Contact Everlast if OC is tripping regularly with normal settings.)	
		Potentiometer damaged.	Repair or Replace it.	
9	Intermittent Arc/ Wandering arc	Control board damaged.	Check the circuit.	
		Work Clamp is not secure or it is damaged. Too windy/breezy.	Check and/or Work Clamp, change position of clamp and attach direct to the work. Move out of wind.	
10	Excessive spatter	Voltage too high too high arc force/ Too high wire speed. Too much torch angle. Wrong size nozzle	Lower voltage or increase wire speed. Check torch angle for less than 15° push or pull. Change arc force settings to reduce spatter. Change nozzle size.	
11	Weld sooty or oxidized looking	Poor metal prep, poor gas flow, too much torch angle, wrong gas type, windy or breezy. Plugged nozzle	Thoroughly clean metal, check gas flow and reposition gun so gas flow is not creating turbulence. Move indoors if necessary. Reposition the welder so its fan will not blow on the weld area. Clean nozzle.	
12	Bird nesting of the wire around the drive roll	Jammed gun liner, wire too soft (aluminum), gun hose is kinked or coiled too tightly. Too much tension / pressure on wire feeder .	Reduce wire feed tension so that drive will slip if it encounters too much resistance Check Gun and liner and replace if necessary. Straighten cable.	
13	Wire feeds irregularly	Wrong drive roller or wrong size drive roller, too little tension on wire, wire in wrong groove.	Check and match wire size to groove size, increase tension on drive rollers. Check to make sure the wire is not riding on the shoulder of the drive roller.	
14	Wire burns back and seizes in tip	Wrong contact Tip size or too much burn back time set.	Match tip size for wire diameter. Reduce burn back time. If using with aluminum, use tip designed for aluminum or use one size larger tip than the wire.	
15	Nozzle arcs to work piece welding	Nozzle plugged with spatter	Check/clean nozzle and use a nozzle dip.	
16	In Stick mode will not arc	Cables not connected, inverter issue	Check connections.	
17	In Stick mode, the rod sticks	Arc force/Hot Start is set too low, arc striking method is poor, wrong polarity, too low of amperage. Wet welding rods or wrong kind.	Check polarity. Check Hot Start settings. Increase arc force control/Hot Start. Change arc striking method. Increase amperage. Use fresh welding rods when possible.	

## Section 4

## Trouble Shooting

NO.	Trouble	Possible Cause	Solution
18	Arc will not start unless lift started.	Points misadjusted, worn or dirty. HF not selected	Check HF point gap. Clean and set to .035" Contact Technical Support for details. Make sure unit is set to HF
19	Tungsten is rapidly consumed.	Inadequate gas flow. Too small of tungsten. Wrong shielding gas. Use only Ar. Using green tungsten. Wrong polarity. Possible contamination of shielding gas from gas supplier.	Check gas flow. Check for Leaks throughout system/regulator/tank. Check for 100% Argon. Use red thoriated or any other type besides Green (Pure) or Zirconiated. Put torch in Negative.
20	Tungsten is contaminated, arc changes to a green color.	Tungsten is dipping into weld. Too long of stick-out.	Check and adjust stick out to minimum 1/8 inch. Tungsten is melting. Reduce amperage or increase tungsten size. Reduce stick-out to less than 1/4".
21	Porosity of the Weld. Discolored weld color. Tungsten is discolored.	Low flow rate of shielding gas. High flow rate of shielding gas. Tungsten stick-out is too far. Too short of post flow period. Wrong TIG cup size. Possible gas leaks internally or externally due to loose fittings. Base metal is contaminated with dirt or grease.	Increase flow rate on regulator. Check for kinks in tubing. Increase post-flow time. Reduce stick-out to less than 1/4". Increase cup size, or use gas lens. Clean metal thoroughly with approved metal cleaner, or use acetone and a rag to clean metal
22	Weld quality is poor. Weld is dirty/oxidized, or porous.	Drafty conditions. Unit is located on the workpiece and is blowing gas off due to fan activity. Solenoid is sticking. Too short of pre-flow or post-flow	Eliminate drafts. Move welder. Check if there is sufficient shielding gas left in tank. Check gas flow. Adjust for higher flow of gas. Listen for audible click of gas solenoid. If no click is heard, then contact Everlast Support. Clean weld properly. Increase pre flow or post flow.
23	Unstable Arc.	Poorly ground or shaped tungsten. Bad work clamp connection. Metal is indirectly connected through table or other item.	Regrind to proper point. Wrong polarity. Place torch in DC negative (-). Connect work clamp directly to item being welded.
24	AC TIG will not weld properly	Wrong connection of work or torch	Check and change immediately.

